

HECKABDECKUNG

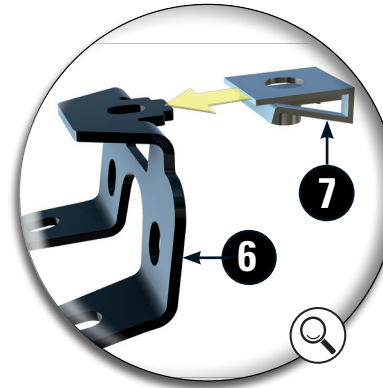







Rear Cover | Couvre-cul | Cubierta trasera | Copertura posteriore

Art.-Nr: 44129-00x

Wunderlich



LEGENDE/Key/Clé Légende

-  **Anbau Tipp**
Fitting tip
Astuce de montage
-  **Achtung**
Attention
Attention
-  **Vergrößerung**
Magnification
Grossissement
-  **Montagepaste**
Fitting lubricant
Lubrifiant de montage
-  **Schraube**
Screw
Vis
-  **Schraubensicherung**
Thread locking fluid
Freinfilets
-  **Drehmoment**
Torque
Torque
-  **Reiniger**
Cleaner
Nettoyant

#	Bauteil component composant	DE Die Farben der Abbildungen dienen nur der Veranschaulichung. EN The colors are for illustrating purposes only. FR Les couleurs utilisées sont à titre indicatif seulement.	DIN	ISO	Menge quantity quantité
1	Heckabdeckung / Rear Cover				1
2	Halter vorne / Front bracket				1
3	Linsenflanschschraube / Lens head screw M6x10		7381	7381	2
4	Einsteckmutter / Insert nut M5				2
5	Linsenflanschschraube / Lens head screw M6x20		7381	7381	2
6	Halter hinten / Rear bracket				1
7	Blechmutter / Sheet nut M5				1
8	Linsenflanschschraube / Lens head screw M5x20		7381	7381	2
9	U-Scheibe PA / Washer PA M5		9021	7093	2
10	U-Scheibe KST / Washer plastic Ø7,4mm M6		125		1
11	Linsenflanschschraube / Lens head screw M6x16		7381	7381	1
12	Schraubensicherung / Thread locking fluid				1

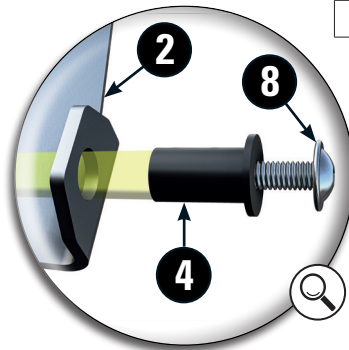
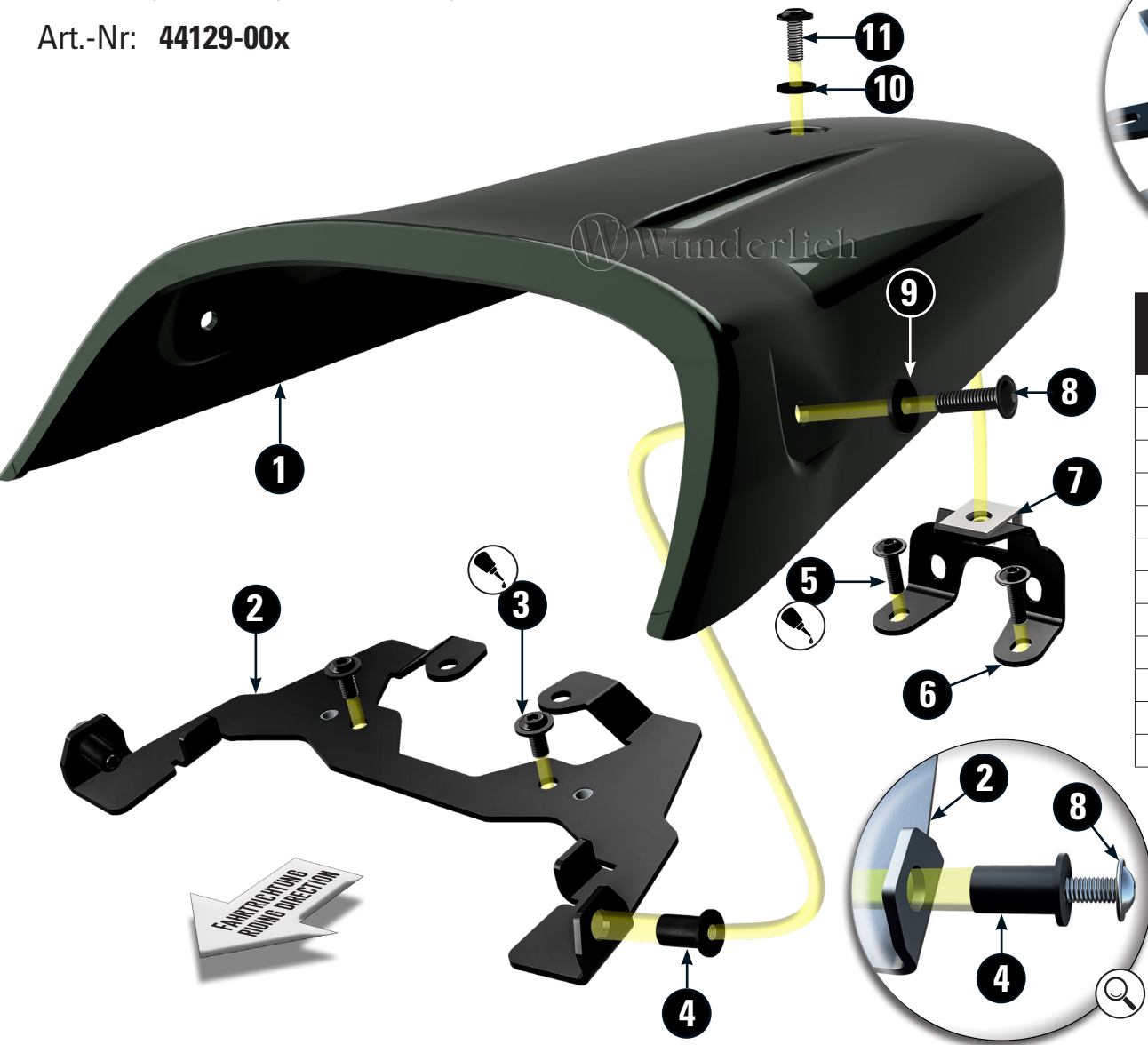

Zum leichteren Einsetzen der Einsteckmutter Schraube ansetzen und an dieser einpressen.

To make inserting the insert nuts easier, position the screw and press it in using it.
Pour faciliter l'insertion des écrous à sertir, positionnez la vis et pressez-la avec celle-ci.



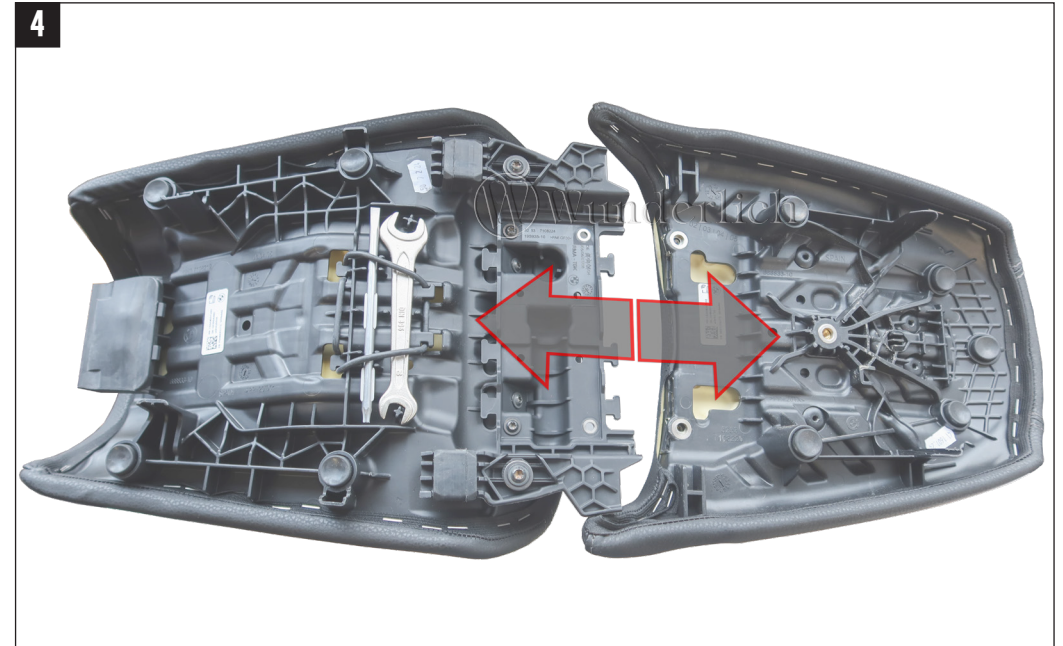
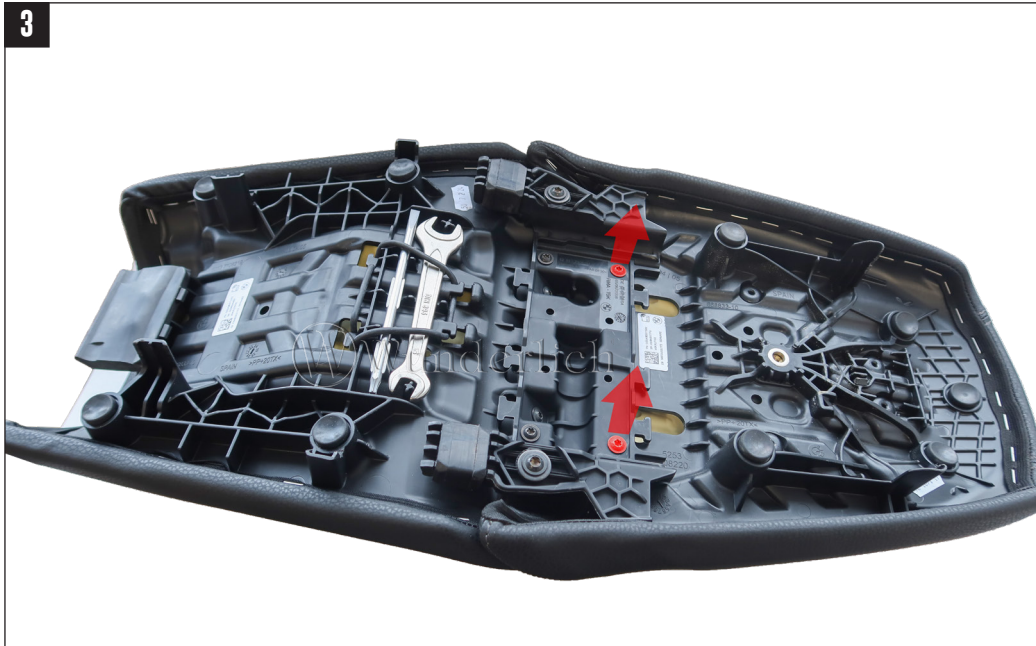

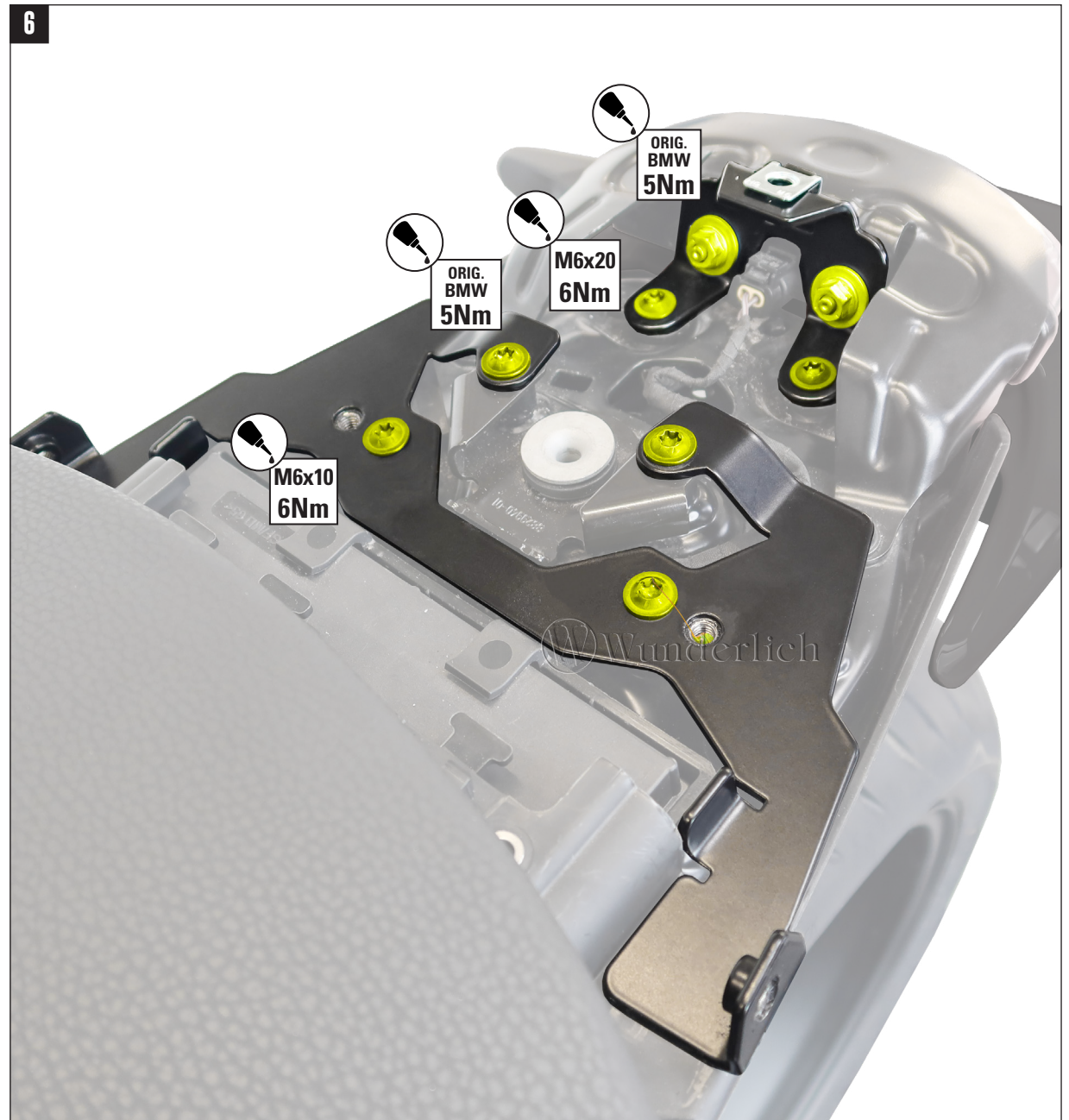
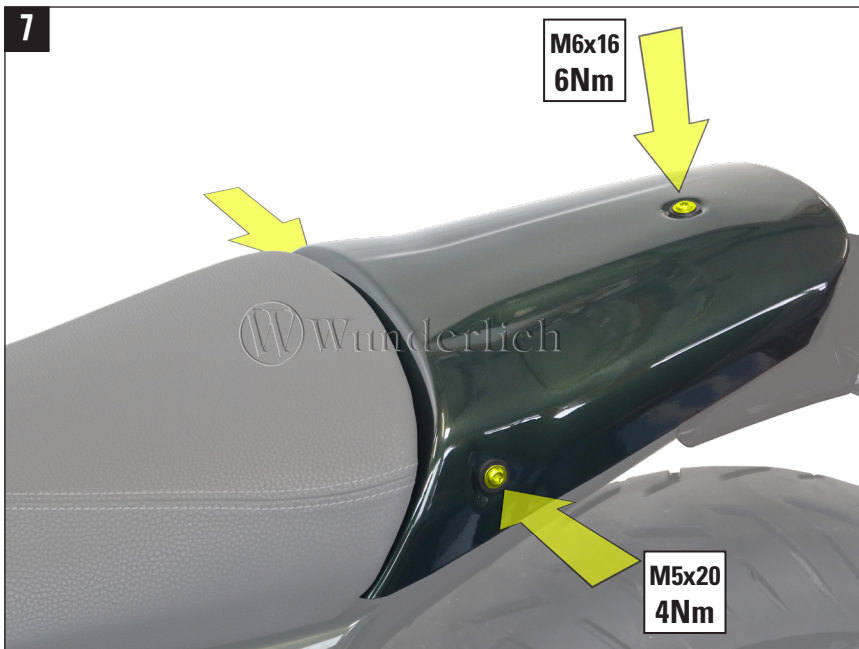
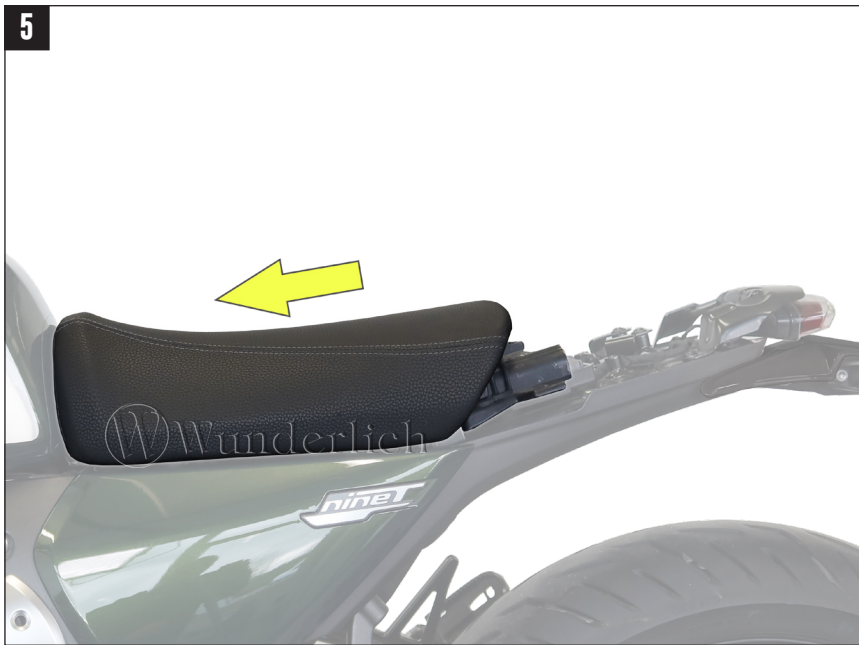

Bitte alle Anbauteile lose am Fahrzeug vormontieren und ausrichten. Erst danach die Schrauben nach Vorgabe anziehen.

First, tighten all screws only loosely. After mounting all parts, the screws should be tightened to the torque specified.

Tout d'abord, ne serrez pas toutes les vis sans les serrer. Après avoir monté toutes les pièces, les vis doivent être serrées au couple spécifié.