

VERKLEIDUNGSSCHEIBE

Windshield | Parabrezza | Pare-brise | Parabrisas

Art.-Nr: 30742-00X / 30744-00X

#	BEZEICHNUNG / DESCRIPTION	DE Die Farben der Abbildungen dienen nur der Veranschaulichung. EN The colors are for illustrating purposes only. FR Les couleurs utilisées sont à titre indicatif seulement.	DIN	ISO	MENGE QUANTITY
1	Verkleidungsscheibe / Windshield				1
2	Linienflanschschraube / lens head screw	M5x20 4Nm	7381SA2	7381SA2	4
3	U-Scheibe / washer	M5	9021SA2	7093	4
4	Gummitülle / rubber grommet				4
5	Stufenhülse / grade sleeve				4

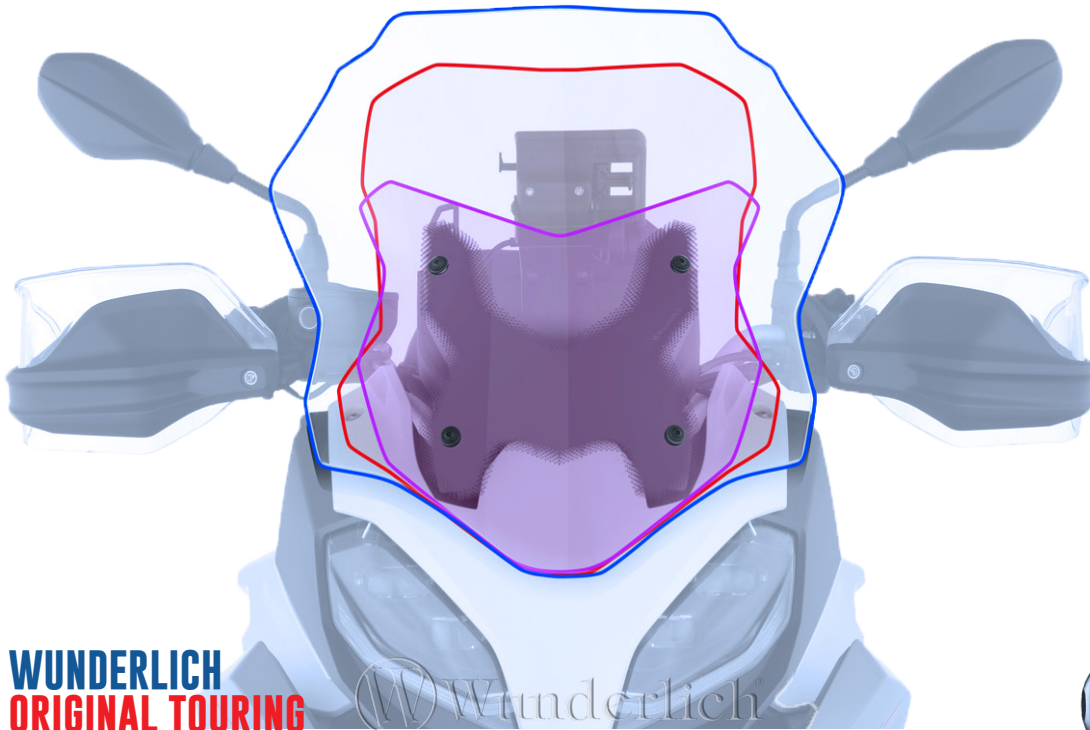

WUNDERLICH
ORIGINAL TOURING
STANDARD

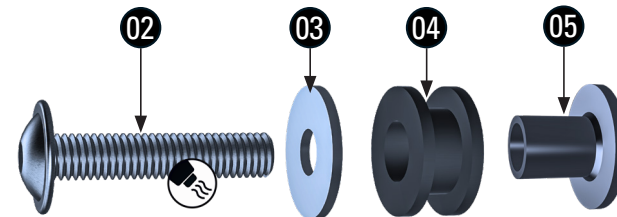
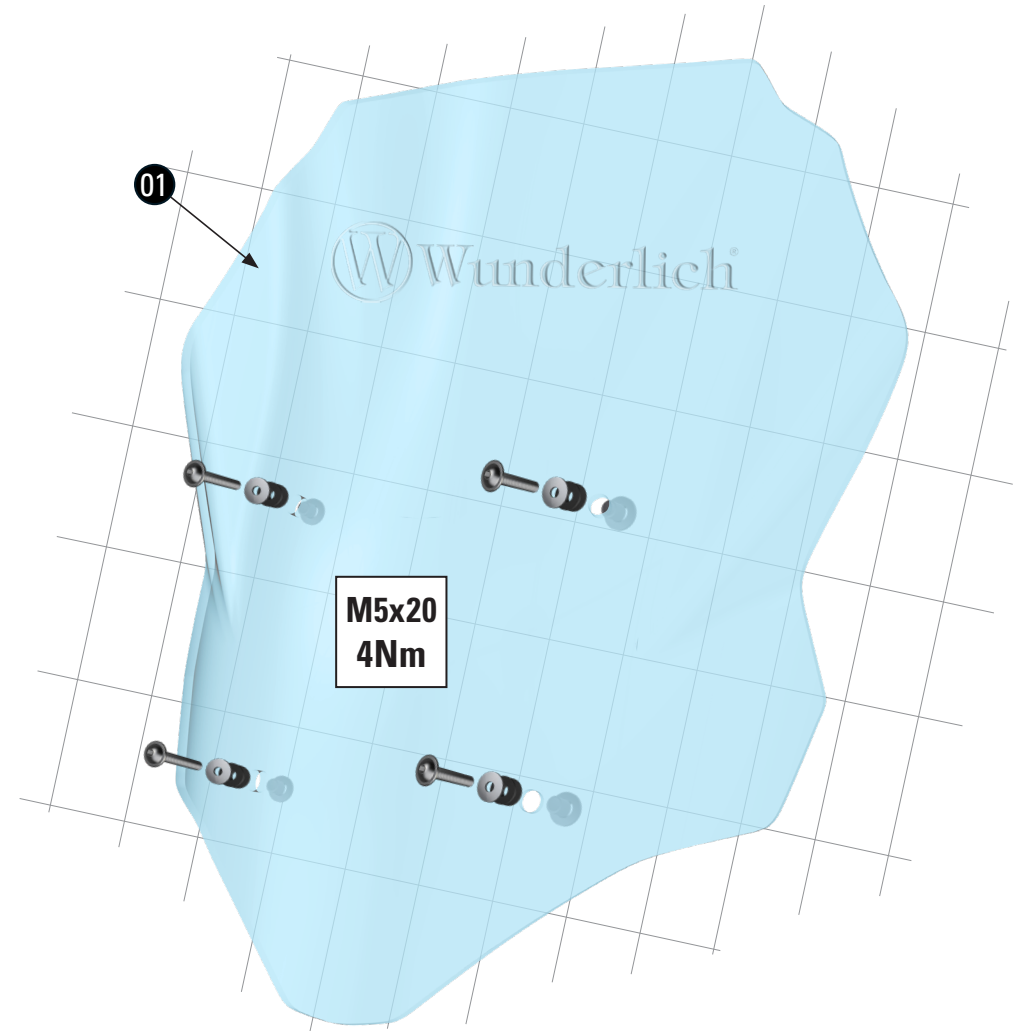

LEGENDE/KEY/FILE LÉGENDE

- Anbau Tipp**
Fitting tip
Astuce de montage
- Achtung**
Attention
Attention
- Vergrößerung**
Magnification
Grossissement
- Montagepaste**
Fitting lubricant
Lubrifiant de montage

- Schraube**
Screw
Vis
- Schraubensicherung**
Thread locking fluid
Freinfilets
- Drehmoment**
Torque
Torque

06.01.26 - 02.04.26









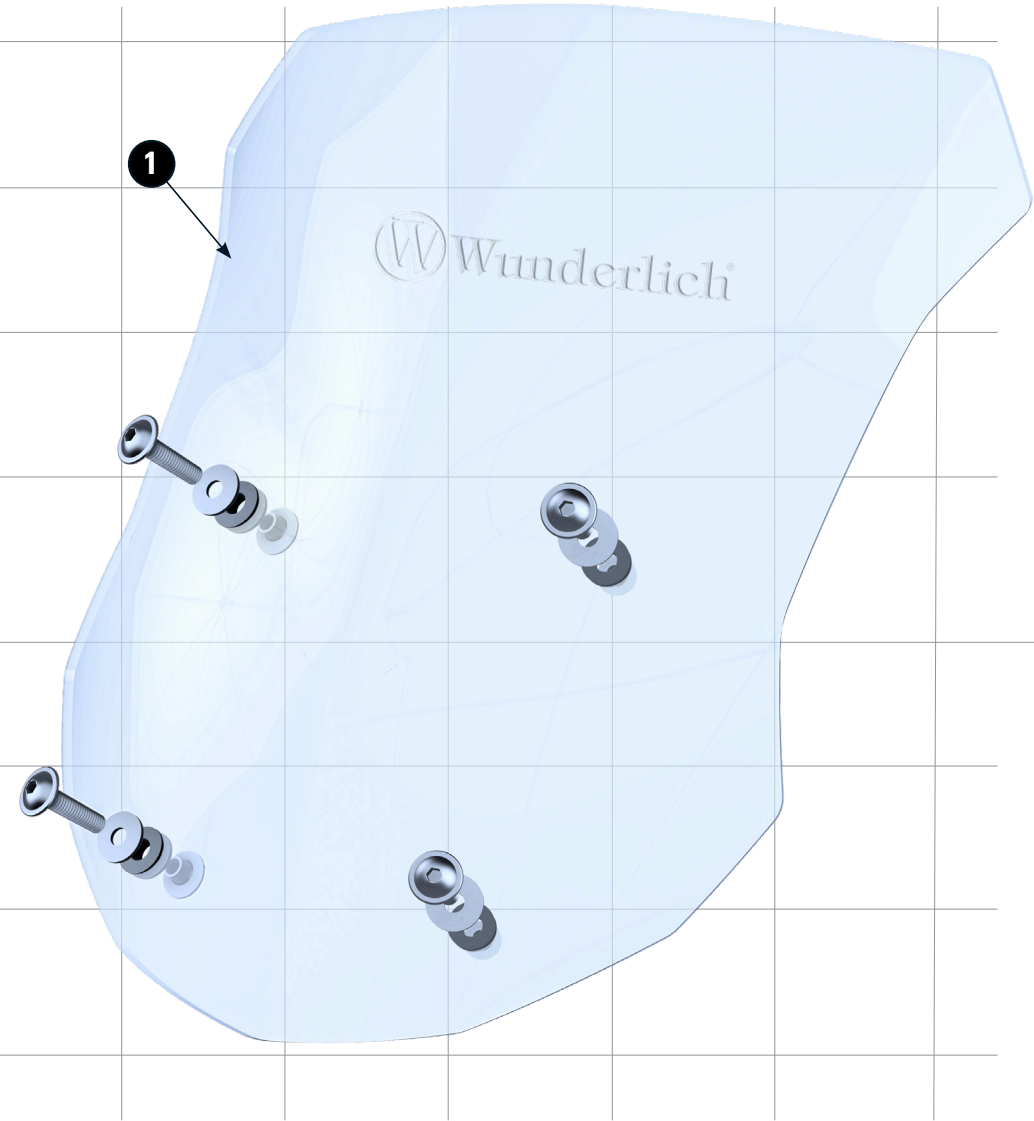
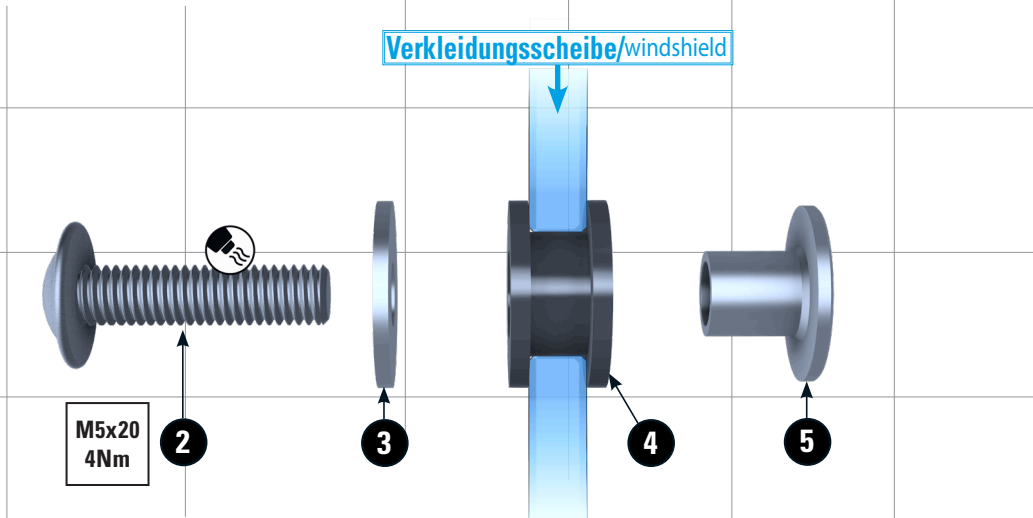

VERKLEIDUNGSSCHEIBE

Windshield | Parabrezza | Pare-brise | Parabrisas

Art.-Nr: 35753-00X / 35756-00X



LEGENDE/KEY/FILE LÉGENDE

-  **Anbau Tipp**
Fitting tip
Astuce de montage
-  **Achtung**
Attention
Attention
-  **Vergrößerung**
Magnification
Grossissement
-  **Montagepaste**
Fitting lubricant
Lubrifiant de montage
-  **Schraube**
Screw
Vis
-  **Schraubensicherung**
Thread locking fluid
Freiniflets
-  **Drehmoment**
Torque
Torque
-  **Reiniger**
Cleaner
Nettoyant

#	BEZEICHNUNG / DESCRIPTION	DE EN FR	DIN	ISO	MENGE QUANTITY
1	Verkleidungsscheibe / windshield	Die Farben der Abbildungen dienen nur der Veranschaulichung. The colors are for illustrating purposes only. Les couleurs utilisées sont à titre indicatif seulement.			1
2	Linsenflanschschraube / lens head screw M5x20mm 4Nm		7381SA2	7381SA2	4
3	U-Scheibe / washer M5		9021SA2	7093	4
4	Gummitülle / rubber grommet				4
5	Stufenhülse / grade sleeve				4

06.01.26 - 02.04.26



1

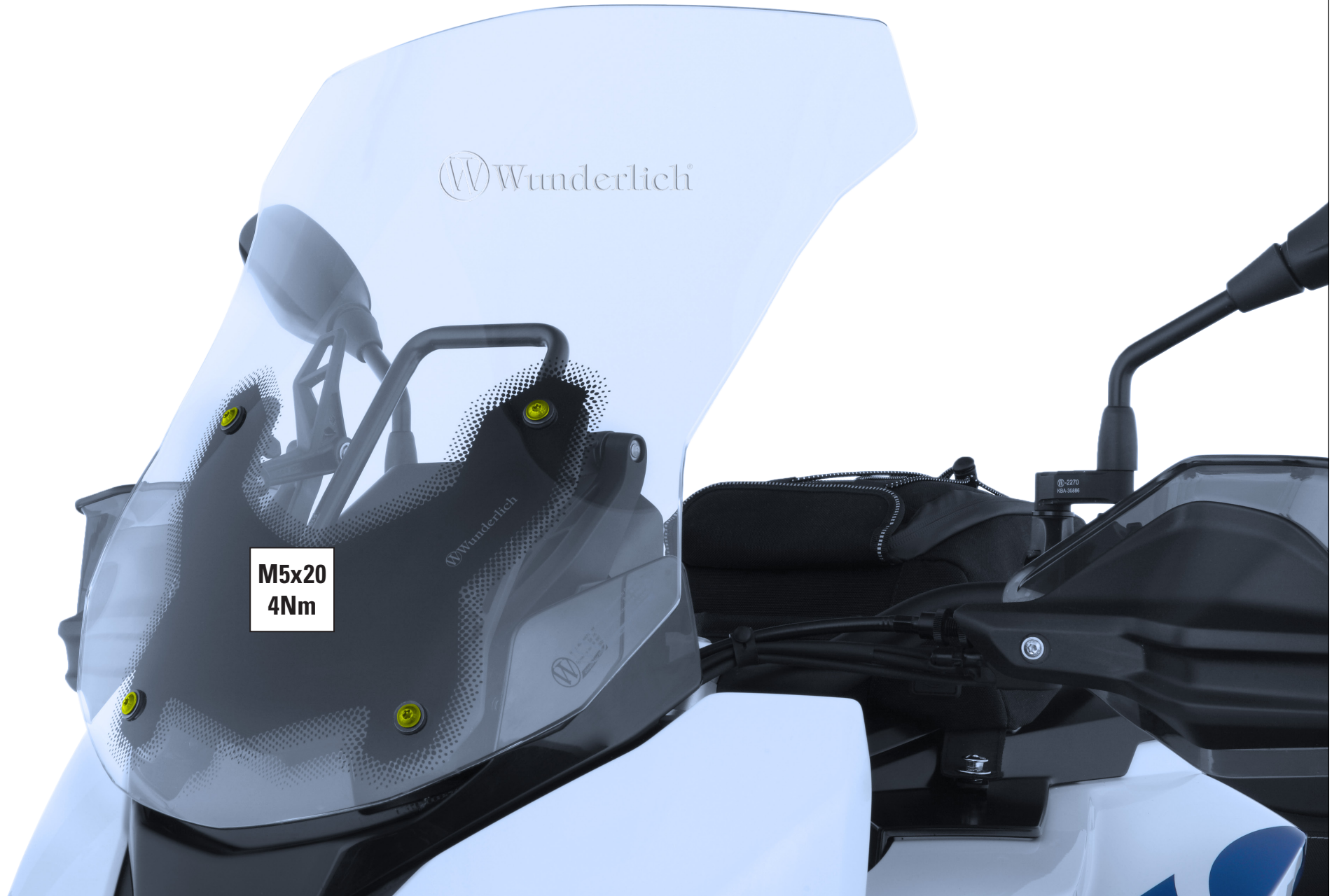

M5x20
4Nm

06.01.26 - 02.04.26



3