

LAMPENSCHUTZGITTER

Lamp grill | Grille de protection pour phare | Griglia di protezione per faro | Rejillas para protección de bombillas

F 850 GS ADVENTURE

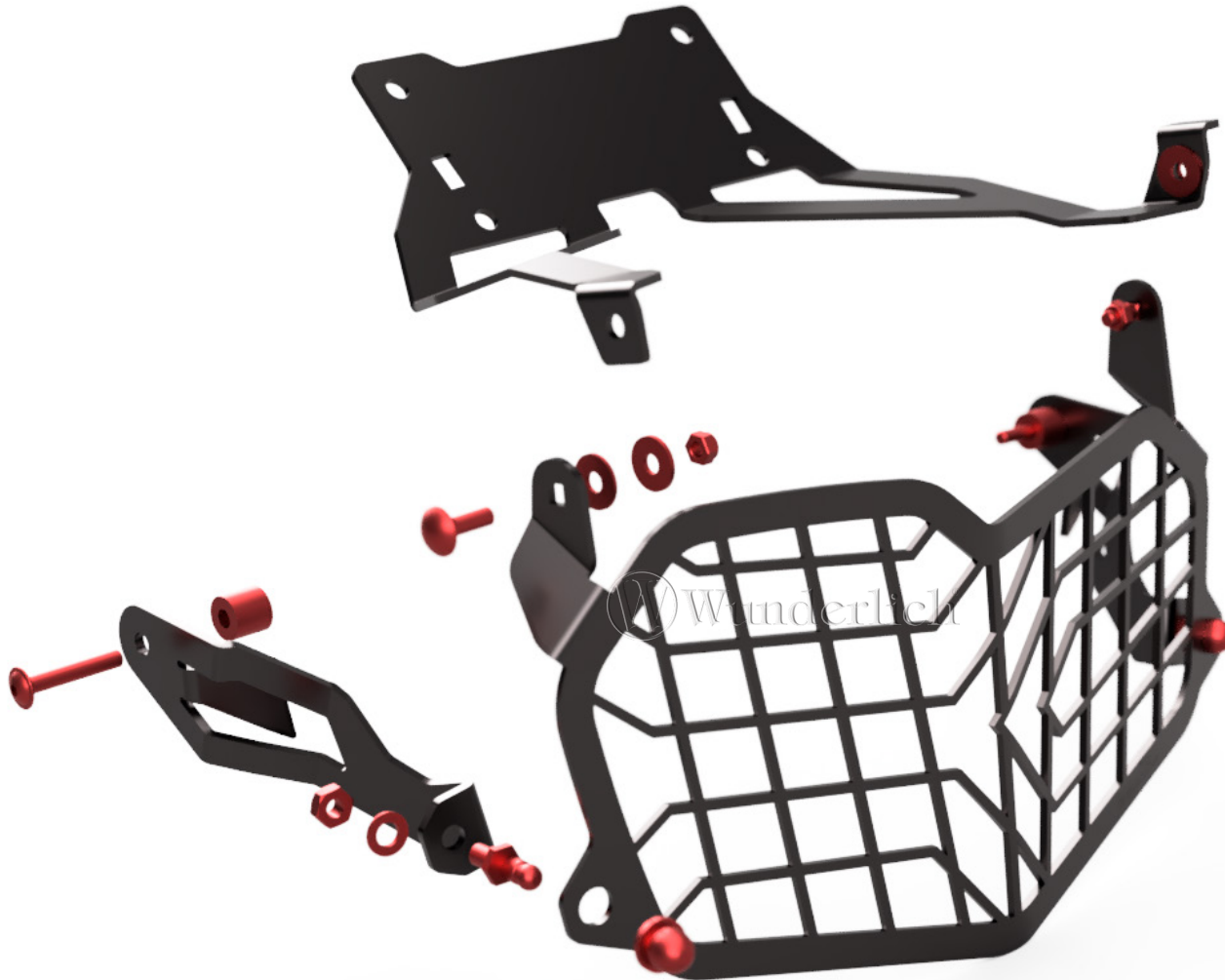



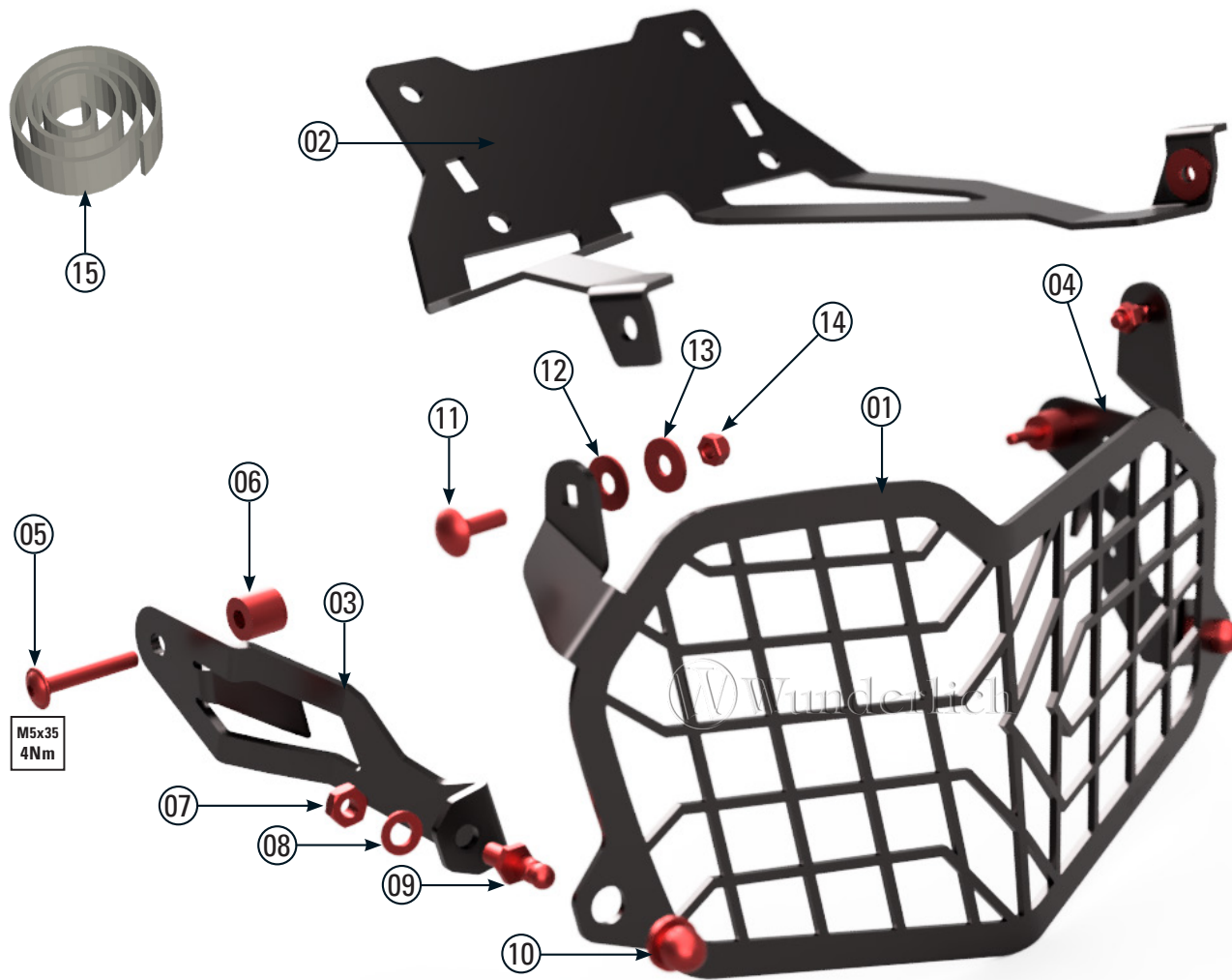



Art.-Nr: 25858-002 / 25858-102





#	BEZEICHNUNG / DESCRIPTION	MENGE / AMOUNT
1	Lampenschutzgitter	1
2	Lampenschutzgitter Halter (oben)	1
3	Halter (rechts)	1
4	Halter (links)	1
5	Linsenflanschschraube M5 x 35 Torx 4 Nm	2
6	Hülse 12mm	2
7	Mutter selbstsichernd M6	2
8	Unterlegscheibe M6	2
9	Snaplock Bolzen	2
10	Snaplock Kupplung	2
11	Schlossschraube M5 x 16	2
12	Unterlegscheibe Teflon M5	2
13	Unterlegscheibe M5	2
14	Mutter selbstsichernd M5	2
15	Moosgummi	15cm

LEGENDE/KEY/FILE LÉGENDE

-  **Anbau Tipp**
Fitting tip
Astuce de montage
-  **Achtung**
Attention
Attention
-  **Vergrößerung**
Magnification
Grossissement
-  **Montagepaste**
Fitting lubricant
Lubrifiant de montage
-  **Schraube**
Screw
Vis
-  **Schraubensicherung**
Thread locking fluid
Freinfilets
-  **Drehmoment**
Torque
Torque
-  **Reiniger**
Cleaner
Nettoyant

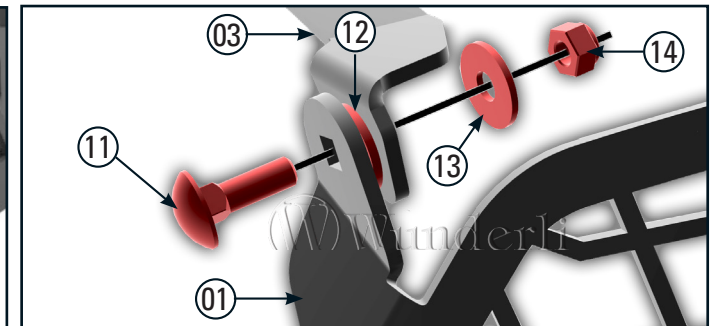
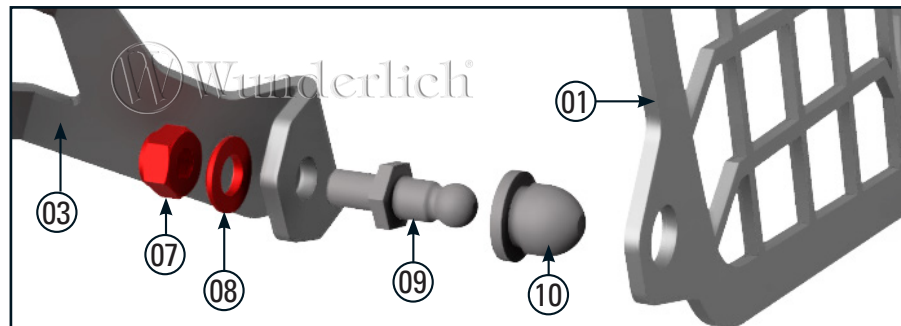
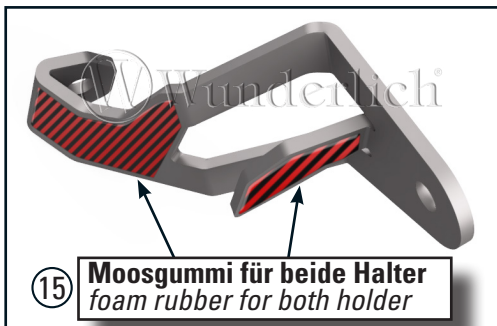



Zum Schutz der Verkleidung, empfehlen wir Lackschutzfolie oder Moosgummi an den rot eingefärbten Stellen anzubringen.
To protect the cladding, we recommend applying paint protection film or sponge rubber to the red colored areas.

Montieren Sie im Anschluss alles in umgekehrter Reihenfolge.
Then assemble everything in reverse order.

