









MONTAGESATZ ZUSATZSCHEINWERFER

Additional headlight mounting kit | Kit de montage de phares additionnels | Kit de montaje de faro adicional | Kit di montaggio faro aggiuntivo

Art.-Nr: 28343-002

LEGENDE/KEY/FILE LÉGENDE

-  **Anbau Tipp**
Fitting tip
Astuce de montage
-  **Achtung**
Attention
Attention
-  **Vergrößerung**
Magnification
Grossissement
-  **Montagepaste**
Fitting lubricant
Lubrifiant de montage
-  **Schraube**
Screw
Vis
-  **Schraubensicherung**
Thread locking fluid
Freiniflets
-  **Drehmoment**
Torque
Torque
-  **Reiniger**
Cleaner
Nettoyant



#	Bauteil component composant	DE Die Farben der Abbildungen dienen nur der Veranschaulichung. EN The colors are for illustrating purposes only. FR Les couleurs utilisées sont à titre indicatif seulement.	DIN	ISO	Menge quantity quantité
1	LED Microflooter - vormontiert / LED Microflooter pre-assembled				2
2	Linsenflanschschraube / Lens head screw M5x18		7381SA2	7381SA2	4
3	Halter (linke Seite) / Bracket (left side)				1
4	Halter (rechte Seite) / Bracket (right side)				1
5	Flachkopfschraube / Flat head screw M6x35		7985Z	14583Z	2
6	U-Scheibe / Washer M6		9021	7093	4
7	Linsenflanschschraube / lens head screw M6x8		7381SA2	7381SA2	2
8	Kabelsatz / Cable set				1
9	Schalter / Switch				1
10	Linsenflanschschraube / Lens head screw M5x16		7381SA2	7381SA2	1
11	Linsenflanschschraube / Lens head screw M6x25		7381SA2	7381SA2	1
12	Schraubensicherung / Thread locking fluid				1
13	Winkelschraubendreher / Offset screwdriver				1
14	Kabelbinder / Zip tie				16
15	U-Scheibe / Washer M5		9021	7093	4

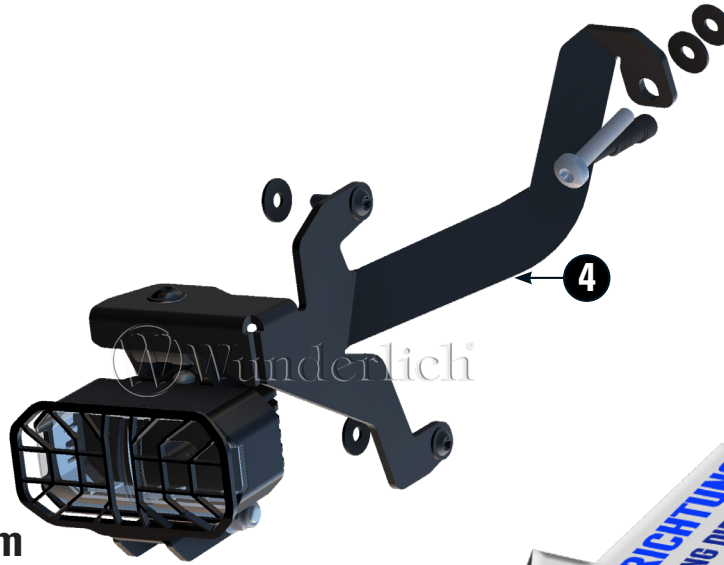

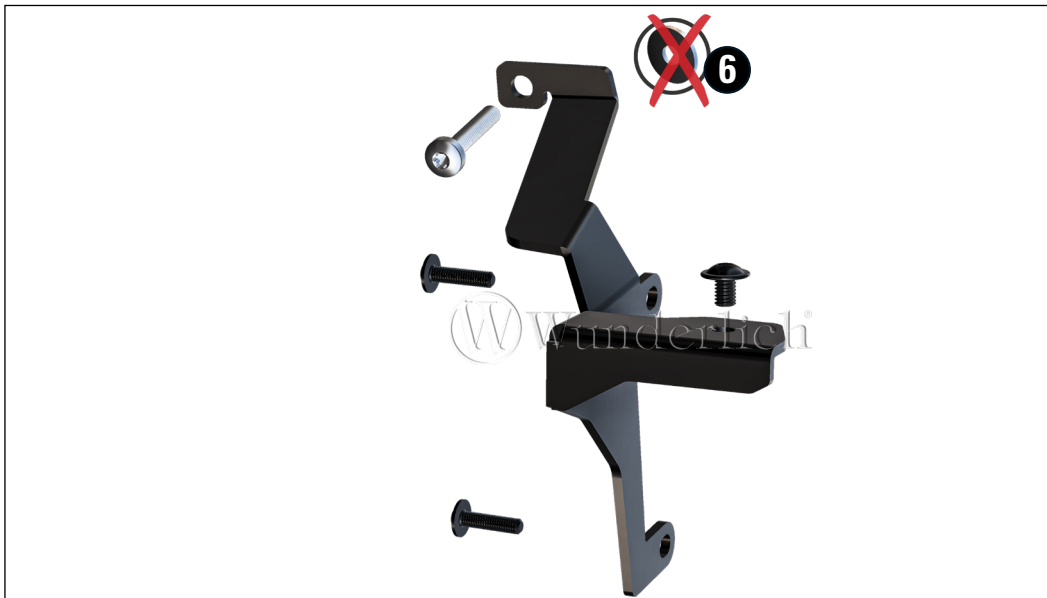
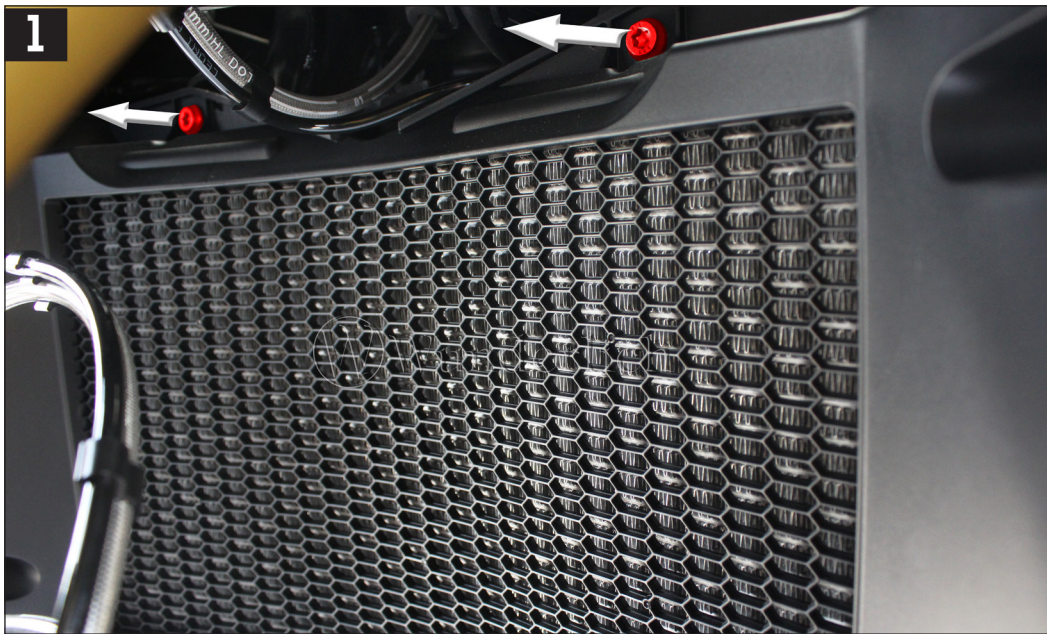

In Kombination mit dem Wasserkühlerschutz Art.-Nr. 25854-00x, entfallen die U-Scheiben.

*In combination with the water radiator guard, item no. 25854-00x, the washers are not required.
En combinaison avec la protection du radiateur d'eau, réf. 25854-00x, les rondelles ne sont pas nécessaires.*

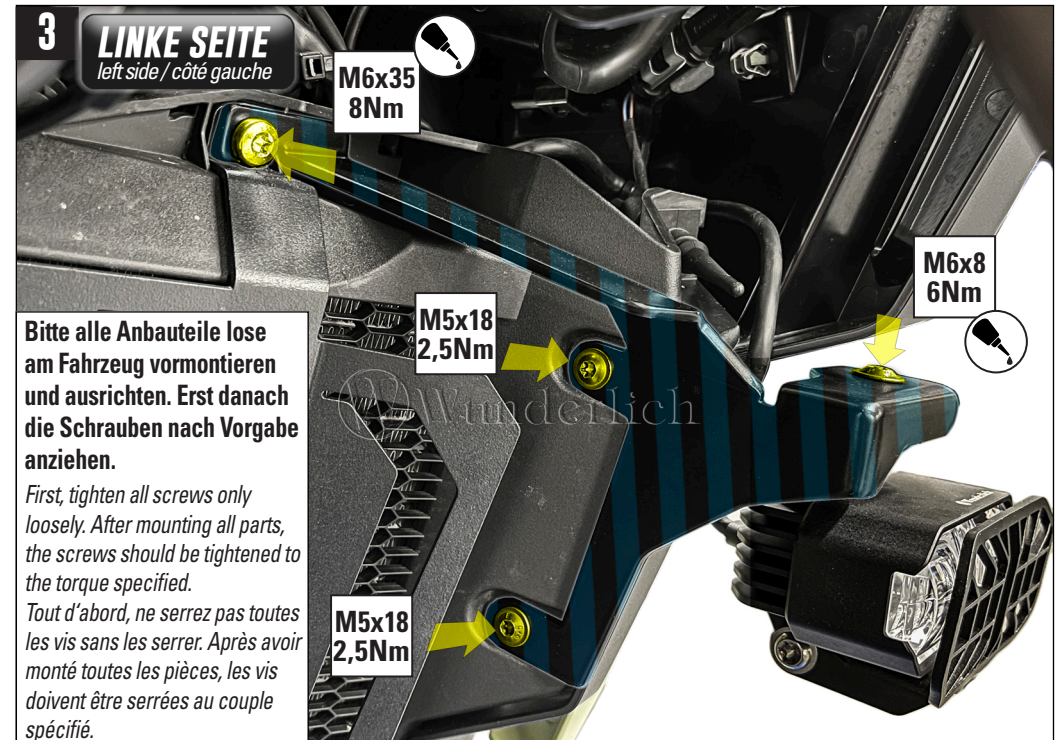

3 LINKE SEITE
left side / côté gauche

Bitte alle Anbauteile lose am Fahrzeug vormontieren und ausrichten. Erst danach die Schrauben nach Vorgabe anziehen.

First, tighten all screws only loosely. After mounting all parts, the screws should be tightened to the torque specified.

Tout d'abord, ne serrez pas toutes les vis sans les serrer. Après avoir monté toutes les pièces, les vis doivent être serrées au couple spécifié.

4 RECHTE SEITE
right side / côté droit

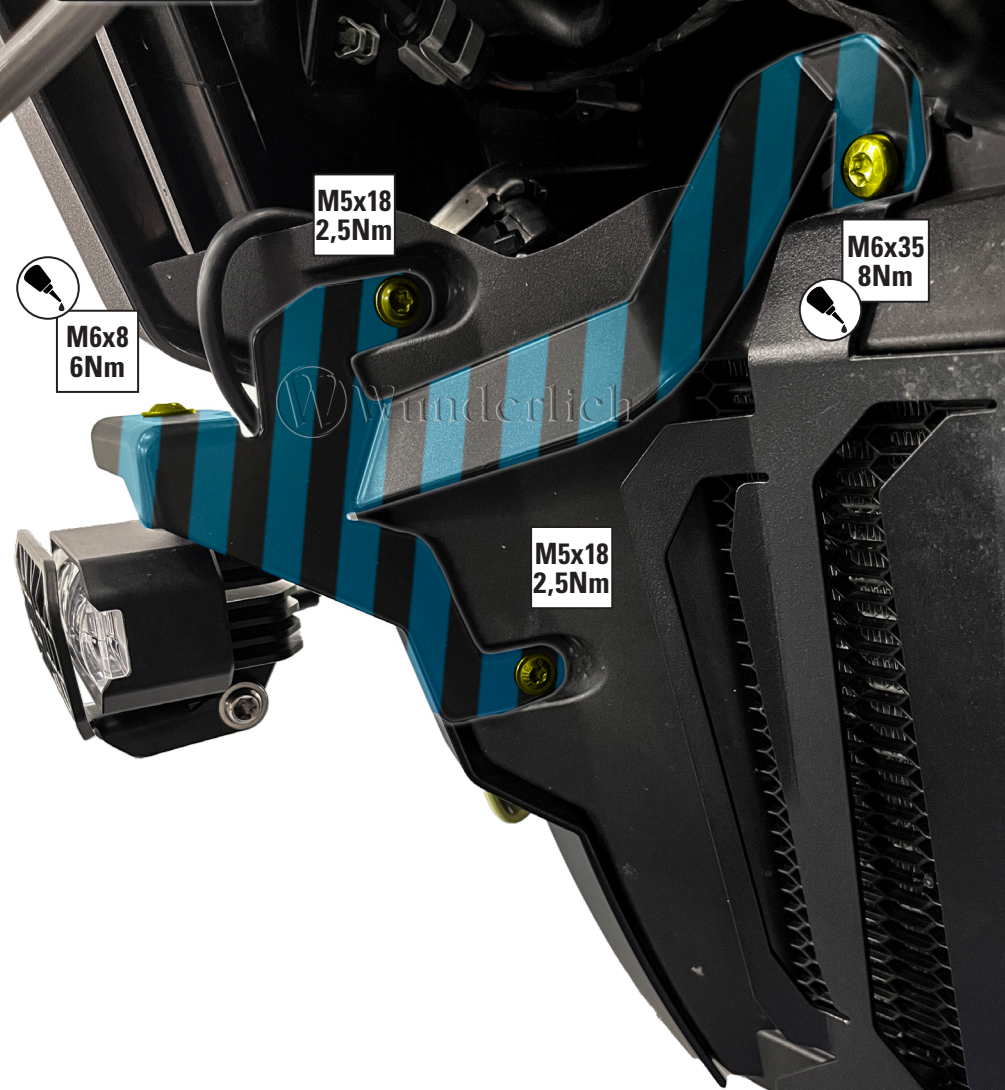

Bitte alle Anbauteile lose am Fahrzeug vormontieren und ausrichten. Erst danach die Schrauben nach Vorgabe anziehen.

First, tighten all screws only loosely. After mounting all parts, the screws should be tightened to the torque specified.
Tout d'abord, ne serrez pas toutes les vis sans les serrer. Après avoir monté toutes les pièces, les vis doivent être serrées au couple spécifié.

5



M6x25
8Nm



6

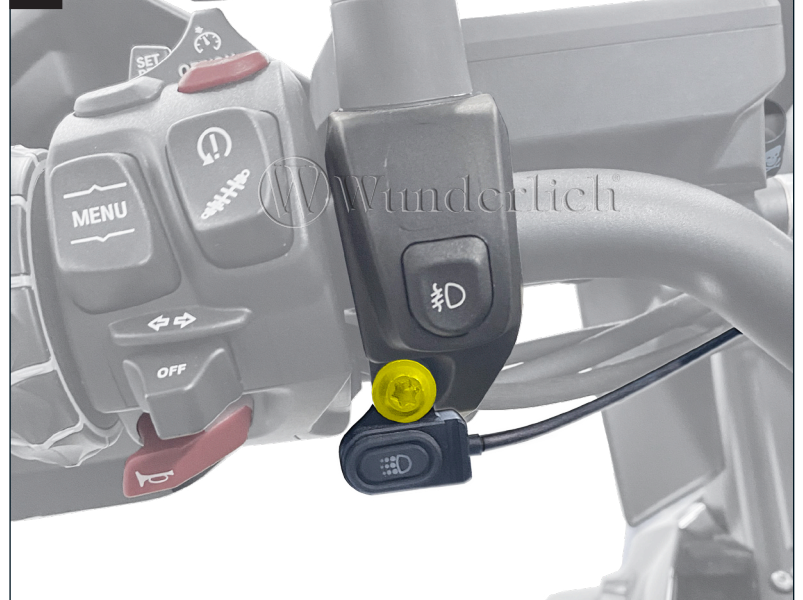

M5x16
2Nm

