

ANBAUSATZ WERKZEUGBOX

Toolbox mounting set | Kit de fixation boîte à outils | Caja de herramientas del kit de fijación | Kit d'attacco cassetta degli attrezzi

Art.-Nr: 13232-102/202



Anbau mit Original Variokofferaufnahme
Attachment with original Vario case mount
Fixation avec support de boîtier Vario d'origine

LEGENDE/KEY/FILE LÉGENDE

- Anbau Tipp**
Fitting tip
Astuce de montage
- Achtung**
Attention
Attention
- Vergrößerung**
Magnification
Grossissement
- Montagepaste**
Fitting lubricant
Lubrifiant de montage
- Schraube**
Screw
Vis
- Schraubensicherung**
Thread locking fluid
Freiniflets
- Drehmoment**
Torque
Torque
- Reiniger**
Cleaner
Nettoyant

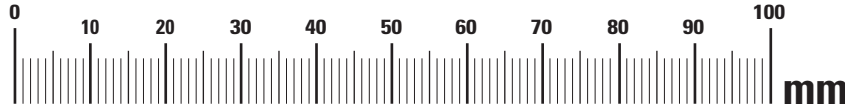
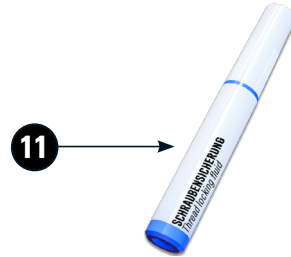

#	Bauteil <i>component</i> <i>composant</i>	DE Die Farben der Abbildungen dienen nur der Veranschaulichung. EN The colors are for illustrating purposes only. FR Les couleurs utilisées sont à titre indicatif seulement.	DIN	ISO	Menge <i>quantity</i> <i>quantité</i>
1	U-Scheibe / Washer		M8 125	7089	2
2	Linsenflanschschraube / Lens flange screw		M6x30 7381	7381	2
3	Linsenkopfschraube mit Pin / Lens head screw with pin		M6x12 7380	7380	5
4	U-Scheibe / Washer		M6 125	7089	5
5	Zylinderschraube / Cylinder screw		M8x45 912SZ	4762	1
6	Zylinderschraube / Cylinder screw		M8x100 912SZ	4762	1
7	Halter unten / Lower bracket				1
8	Halter oben / Upper bracket				1
9	Hülse / Sleeve	ØD 14,5mm - Ød 8,5mm - h 33 mm			1
10	Bit / Bit	1/4" Torx 30			1
11	Schraubensicherung / Thread locking fluid				1
	Zusammenbau Werkzeugbox / <i>Toolbox assembly</i> Schließblech / <i>Strike plate</i>				1
	Passscheibe / Adjusting washer	DØ 13,5mm - h 0,5 mm			1
	Linsenflanschschraube / Lens flange screw		M4x6 7381	7381	1

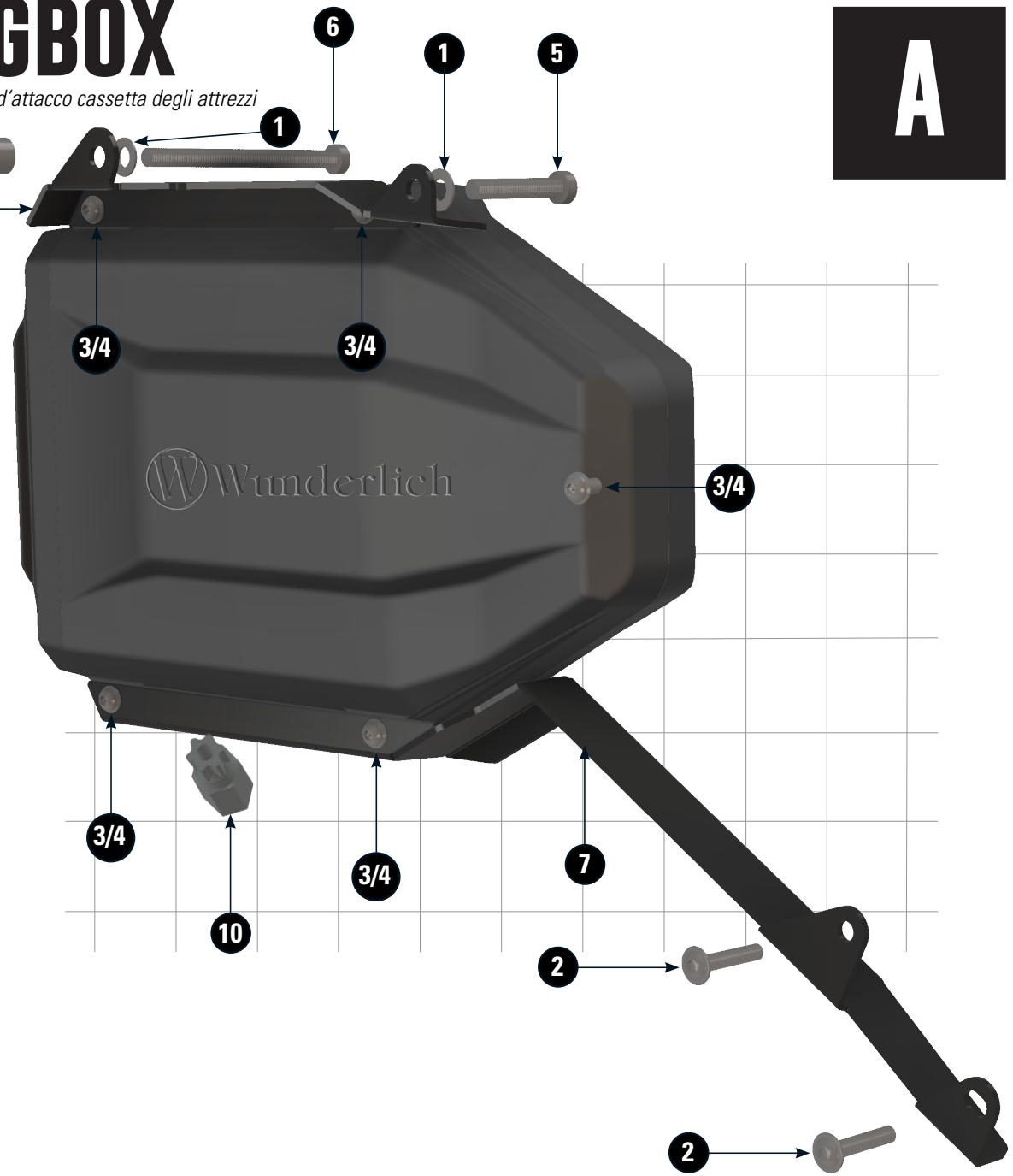

150124



Anbau ohne Original Variokofferaufnahme
 Attachment without original Vario case mount
 Fixation sans support de boîtier Vario d'origine

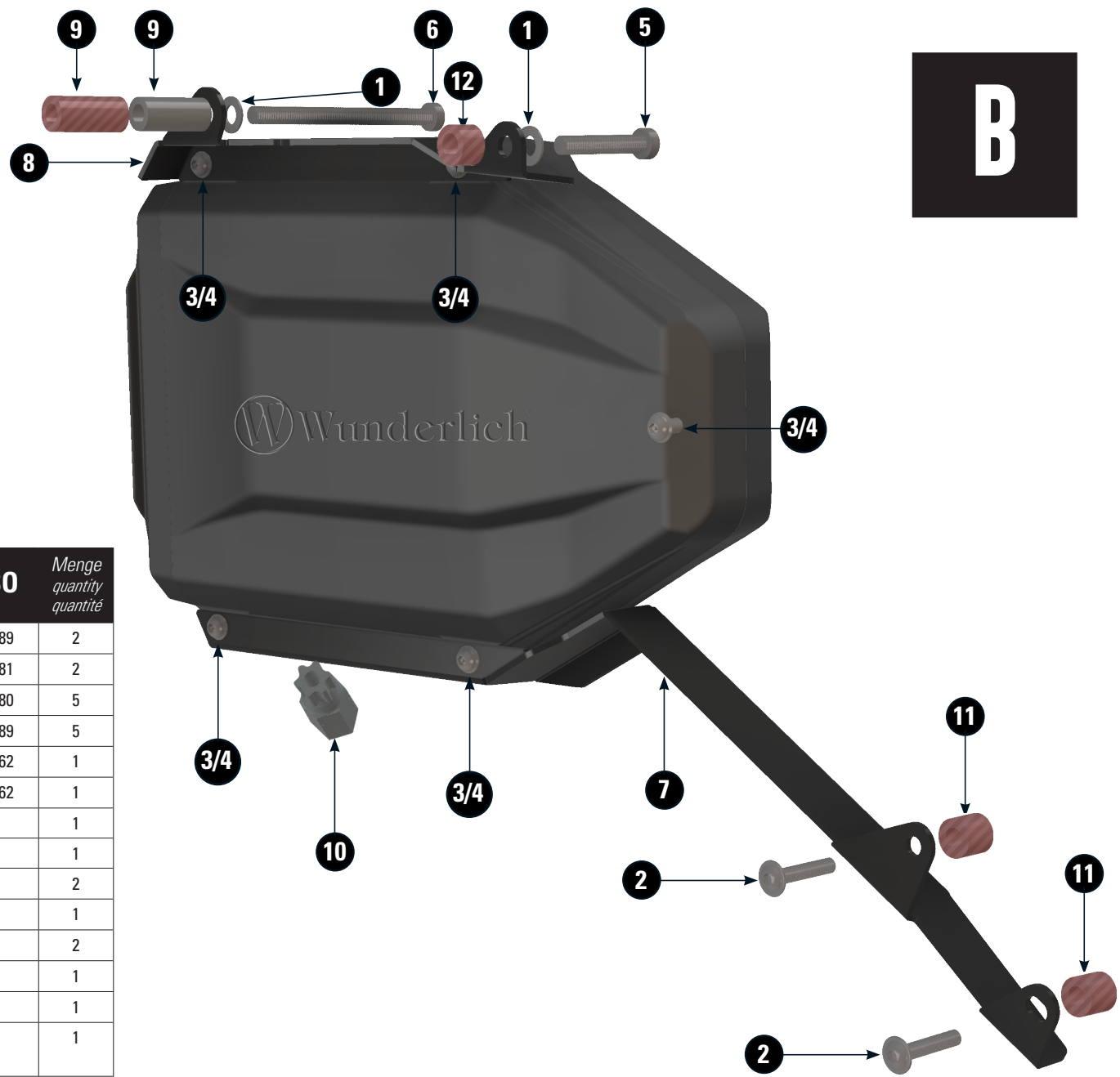

#	Bauteil component composant	DE Die Farben der Abbildungen dienen nur der Veranschaulichung. EN The colors are for illustrating purposes only. FR Les couleurs utilisées sont à titre indicatif seulement.	DIN	ISO	Menge quantity quantité	
1	U-Scheibe / Washer		M8	125	7089	2
2	Linsenflanschschraube / Lens flange screw		M6x35	7381	7381	2
3	Linsenkopfschraube mit Pin / Lens head screw with pin		M6x12	7380	7380	5
4	U-Scheibe / Washer		M6	125	7089	5
5	Zylinderschraube / Cylinder screw		M8x45	912SZ	4762	1
6	Zylinderschraube / Cylinder screw		M8x100	912SZ	4762	1
7	Halter unten / Lower bracket					1
8	Halter oben / Upper bracket					1
9	Hülse / Sleeve	ØD 14,5mm - Ød 8,5mm - h 33 mm				2
10	Bit / Bit	1/4" Torx 30				1
11	Hülse / Sleeve	ØD 13mm - Ød 7mm - h 12mm				2
12	Hülse / Sleeve	ØD 14,5mm - Ød 8,5mm - h 10 mm				1
13	Schraubensicherung / Thread locking fluid					1
	Zusammenbau Werkzeugbox / Toolbox assembly Schließblech / Strike plate					1
	Passscheibe / Adjusting washer	DØ 13,5mm - h 0,5 mm				1
	Linsenflanschschraube / Lens flange screw	M4x6	7381	7381		1

MONTAGE HALTER AN WERKZEUGBOX

Mounting bracket on tool box | Support de montage sur boîte à outils | Supporto di montaggio sulla cassetta degli attrezzi | Soporte de montaje en caja de herramientas

A/B

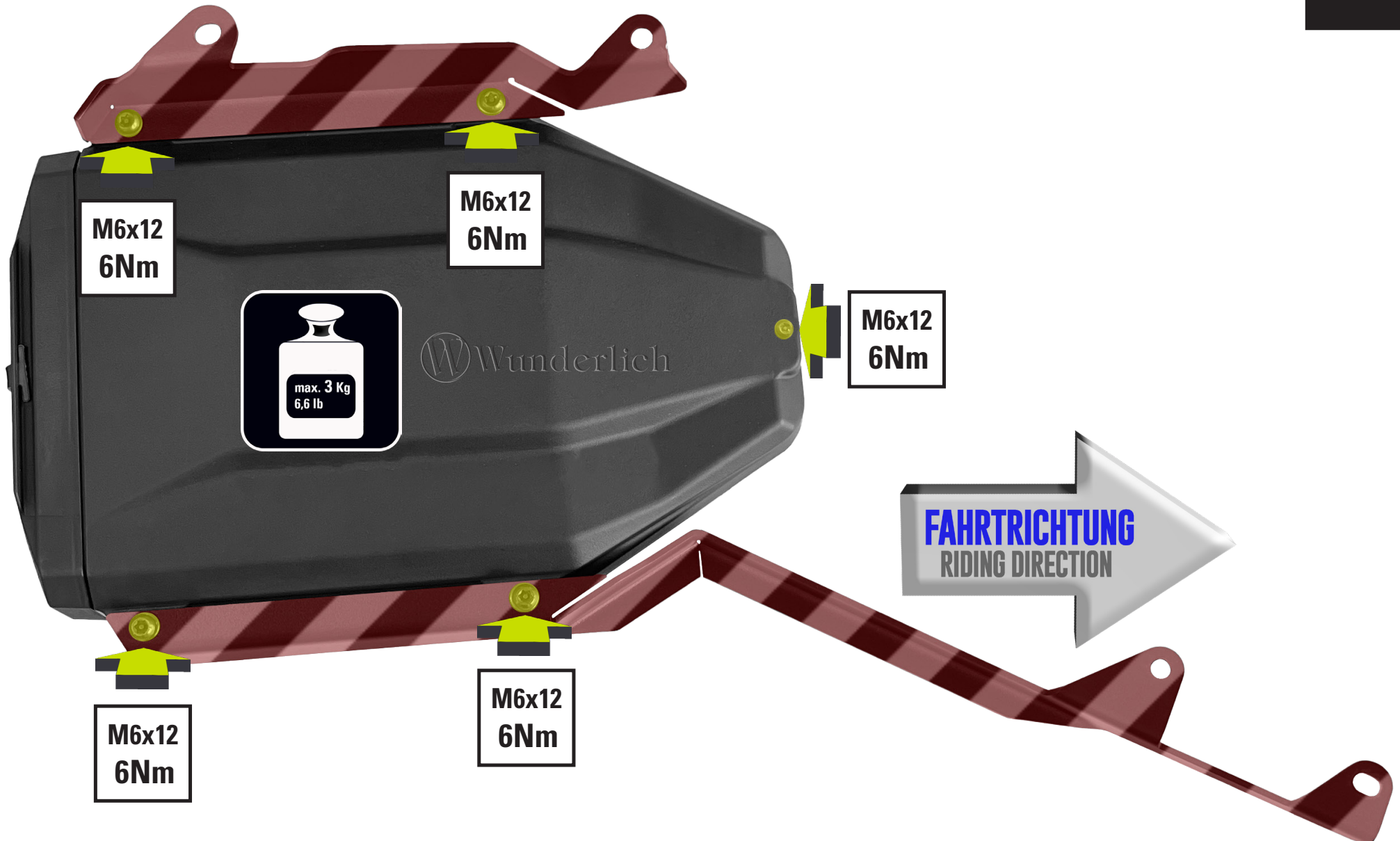

A.1



A.2



A.3

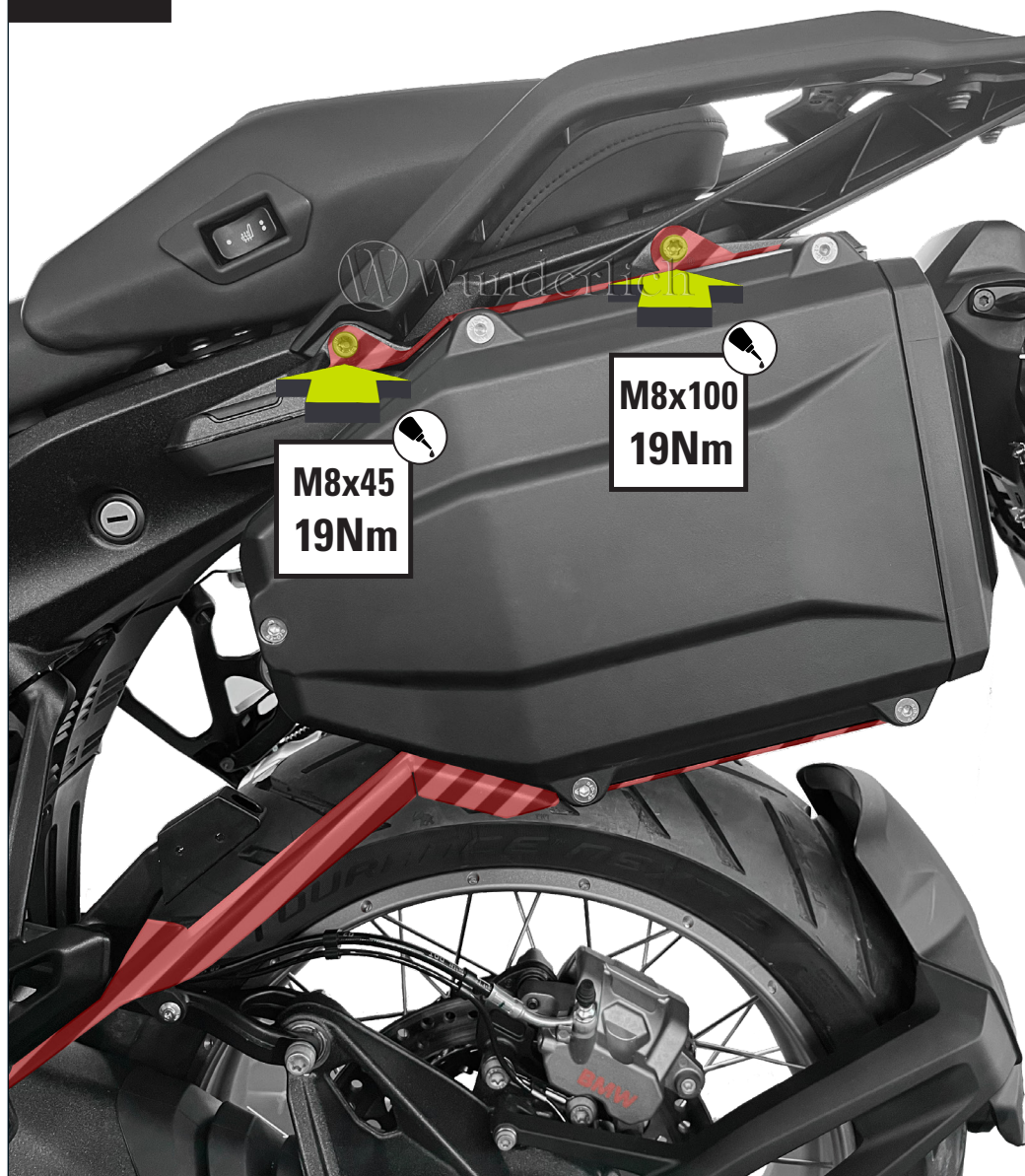

A.4

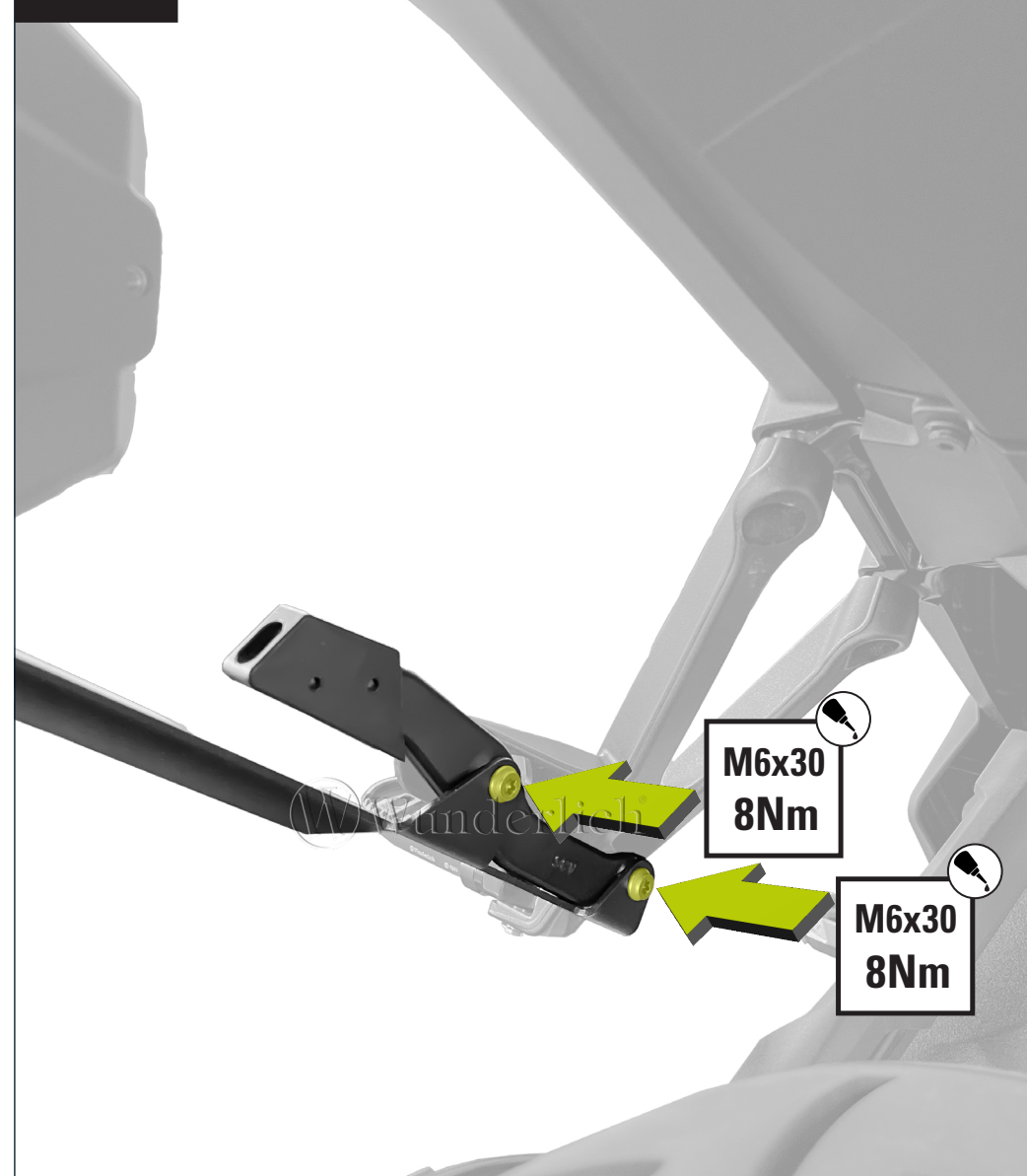

B.1

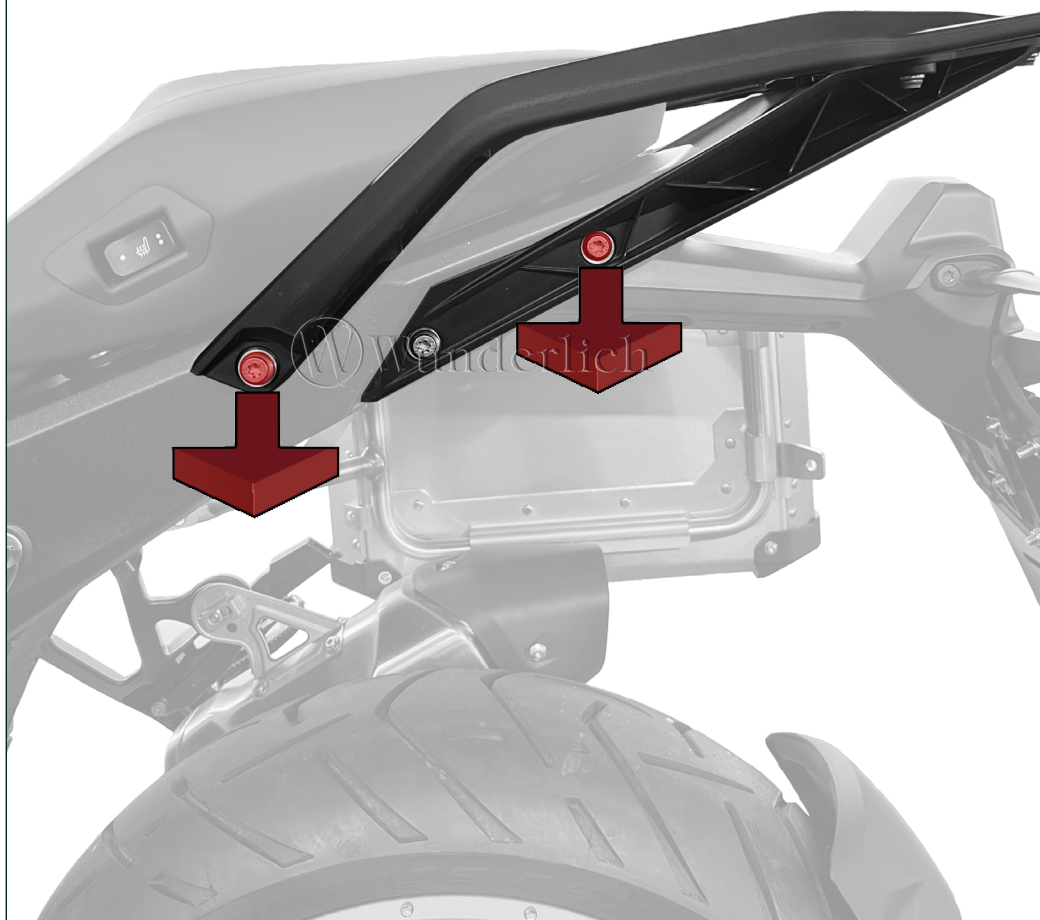

B.2

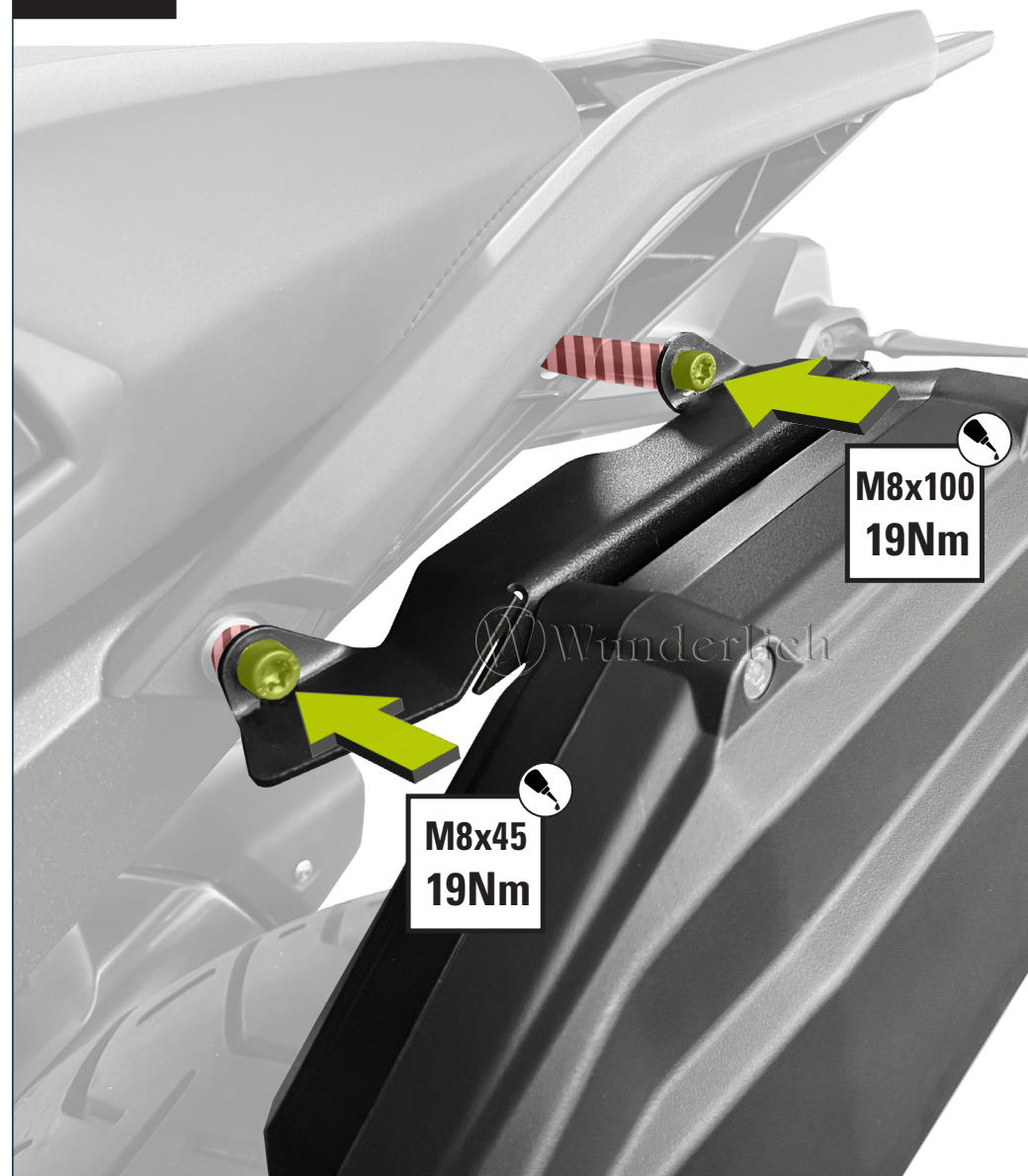

B.3

