

# ABDECKUNG EINSPRITZANLAGE

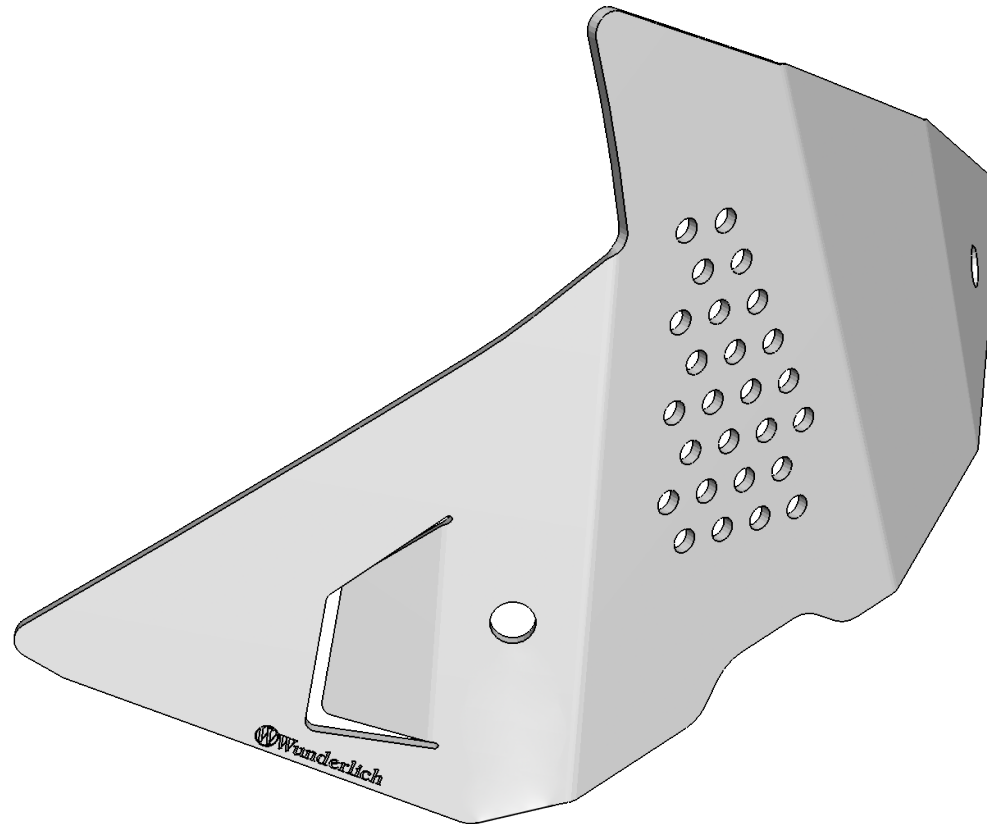

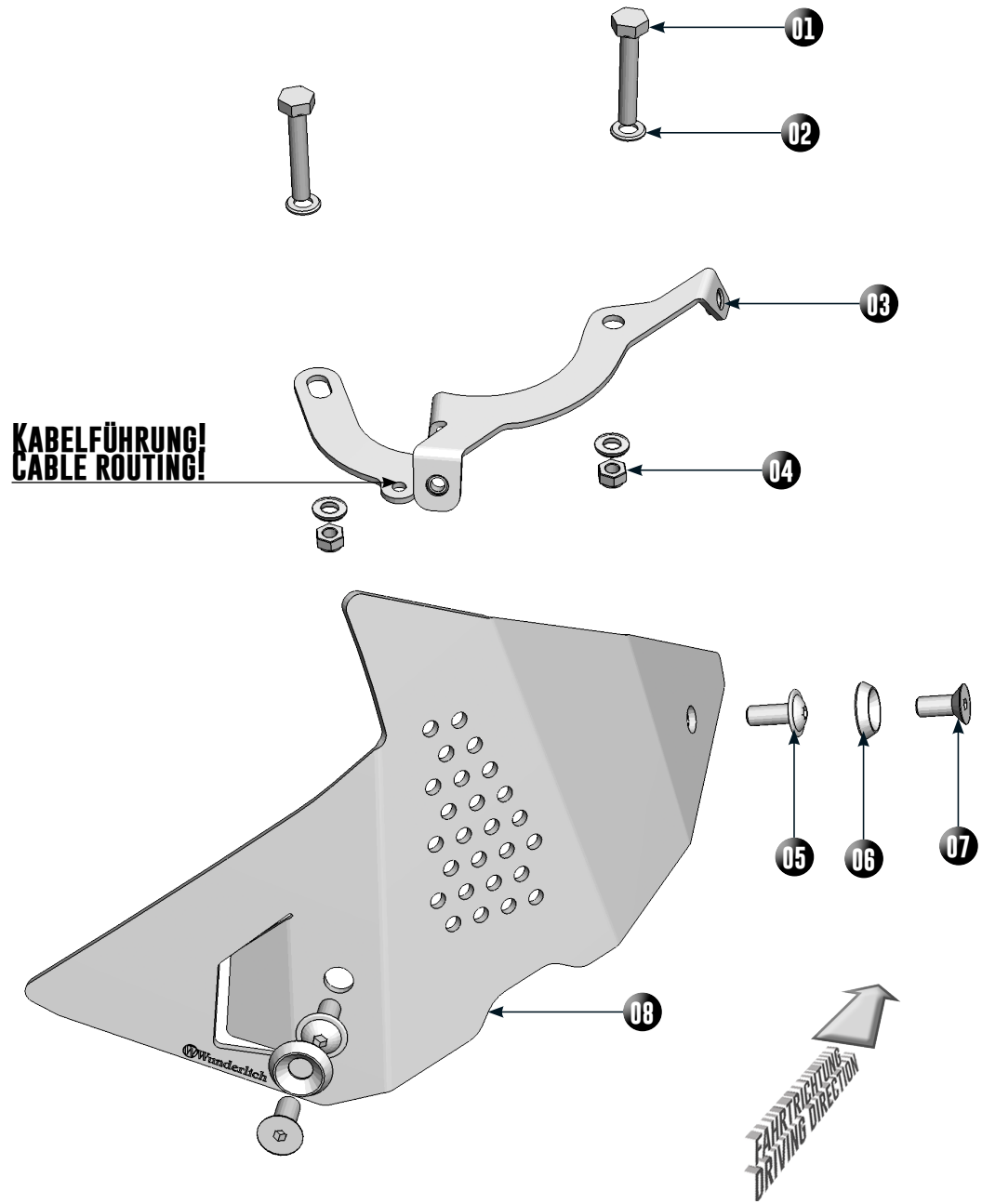



Fuel injection cover | Para sistema de inyección derecha | Capot de système d'injection | Coperichio pompa a iniezione

Art.-Nr: 42940-502





**LEGENDE / KEY**

-  Anbau Tipp  
Fitting tip
-  Achtung  
Attention
-  Vergrößerung  
Magnification
-  Schraube  
Screw
-  Schraubensicherung  
Thread locking fluid
-  M10x14  
Nm Drehmoment  
Torque

#	BEZEICHNUNG / DESCRIPTION	MENGE / AMOUNT
1	Sechskantschraube M5 x 30	2
2	U-Scheibe M5	4
3	Grundhalter rechts	1
4	Sechskantmutter M5	2
5	Linsenkopfschraube M5 x 12 3,5Nm	2
6	RO-9255A4-M5 / Alternativ	2
7	Senkkopfschraube M5 x 12 Alternativ	2
8	Abdeckung rechts	1

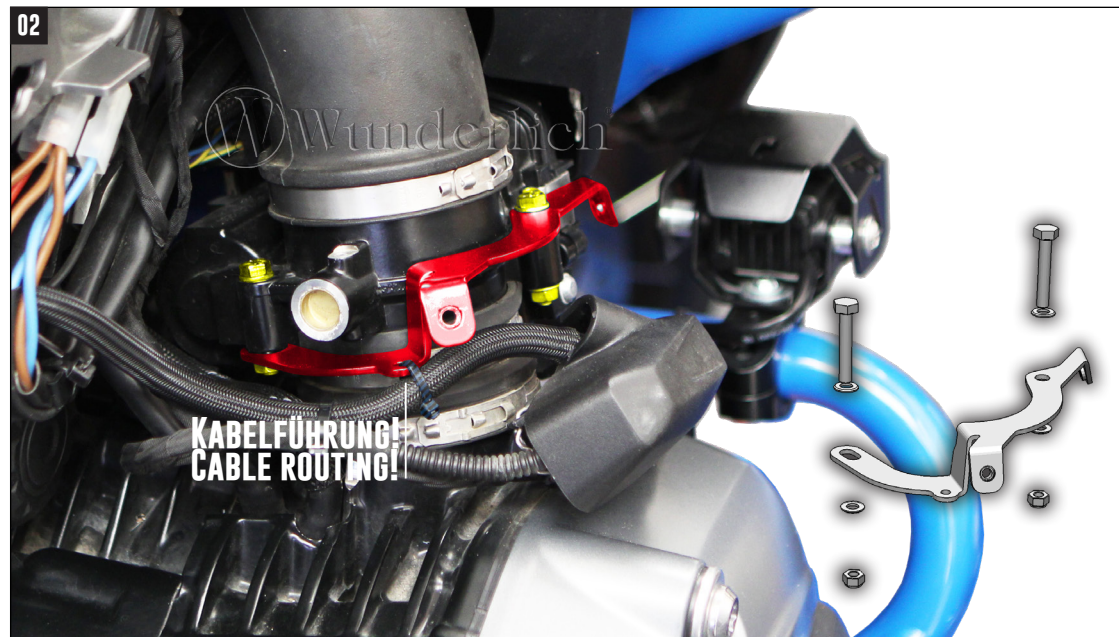
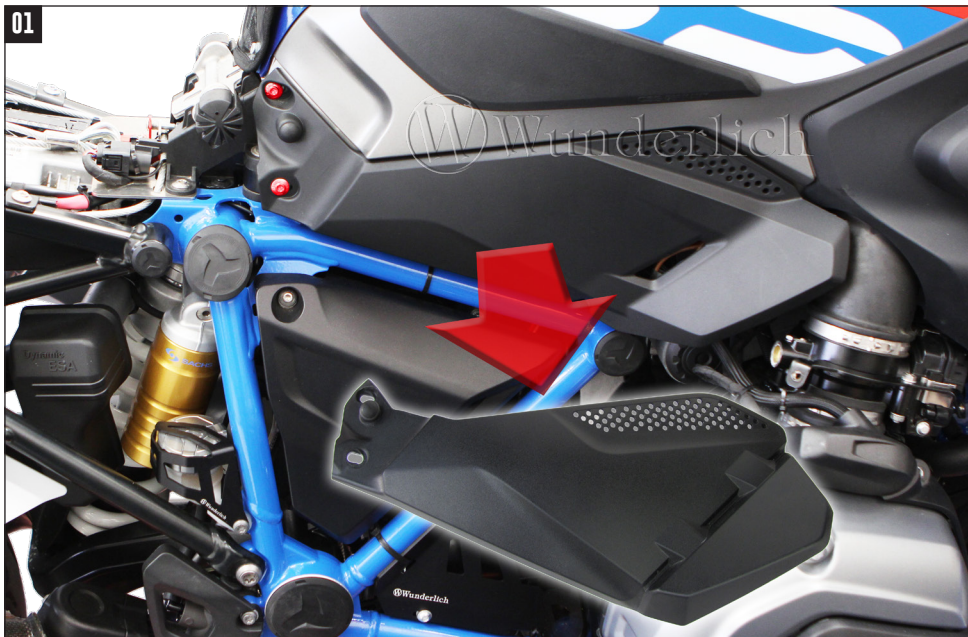

**Halter ausrichten!**  
*Align holder!*

