

# SITZBANK

Seat | Asiento | Selle | Sella

Art.-Nr: 44118-10x

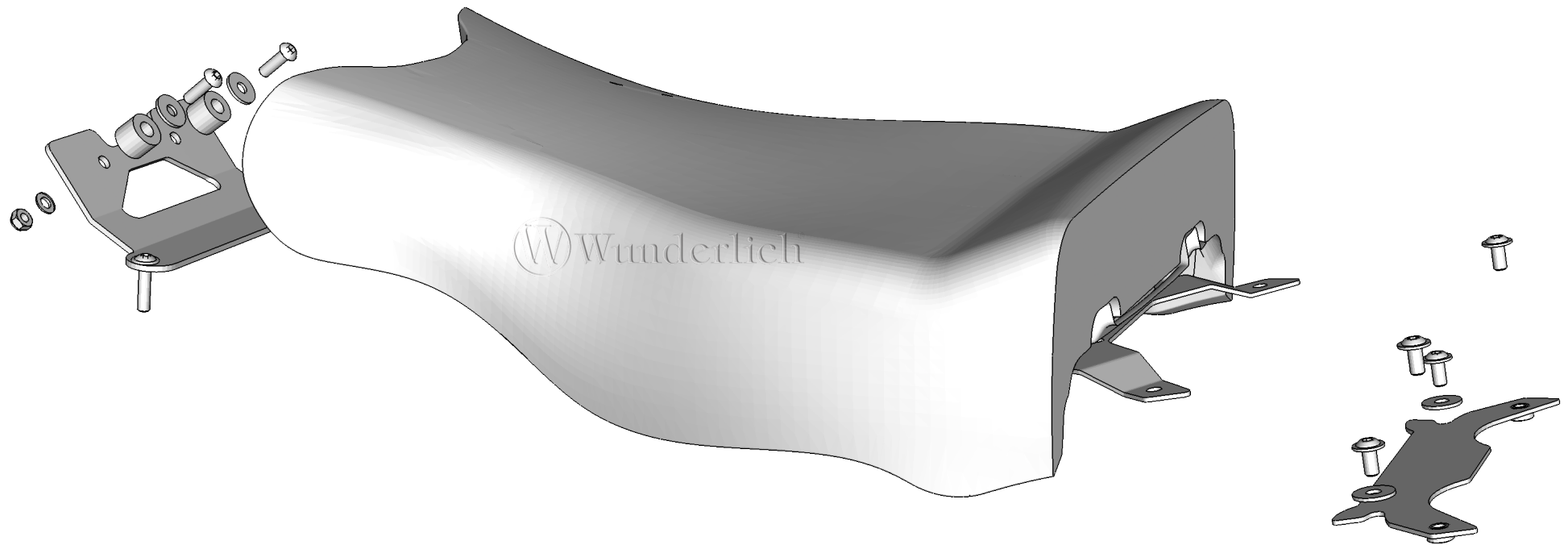

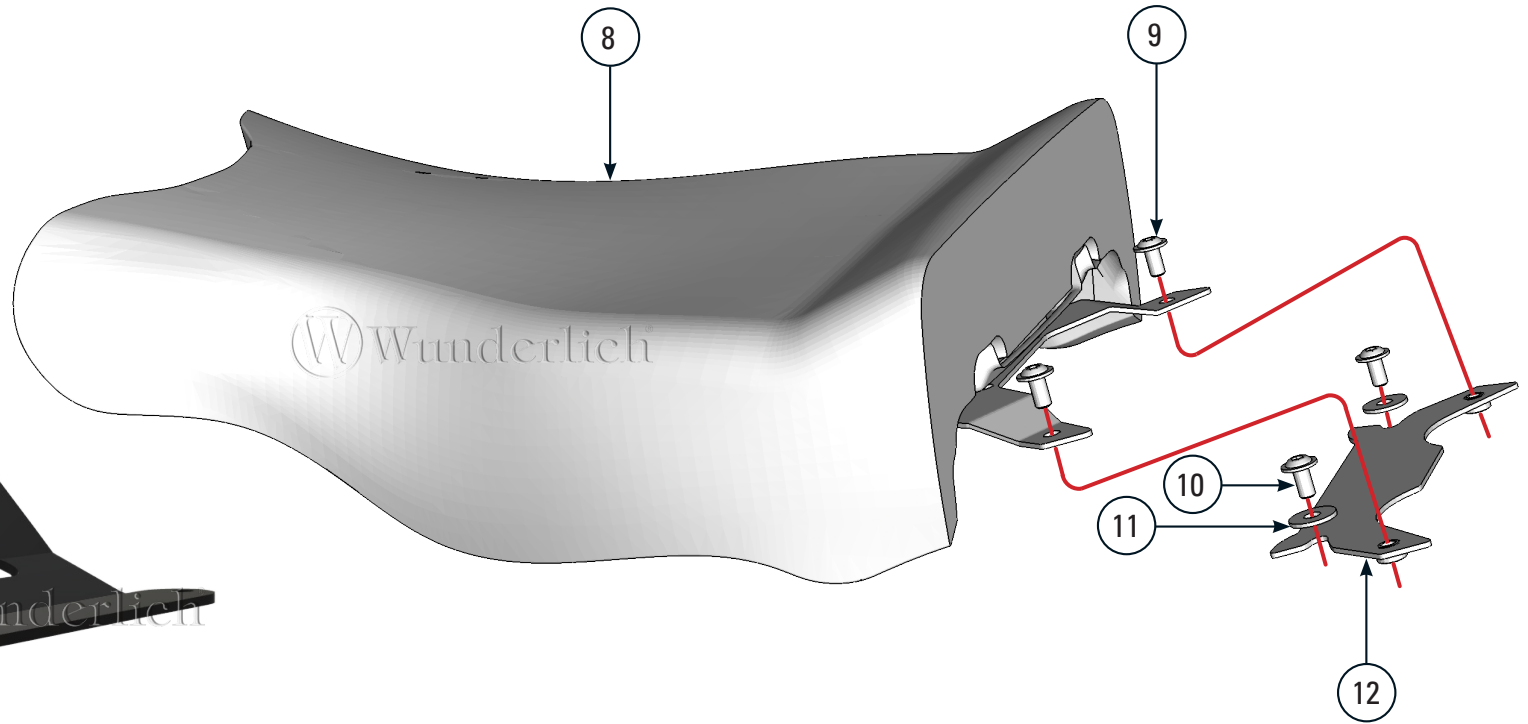
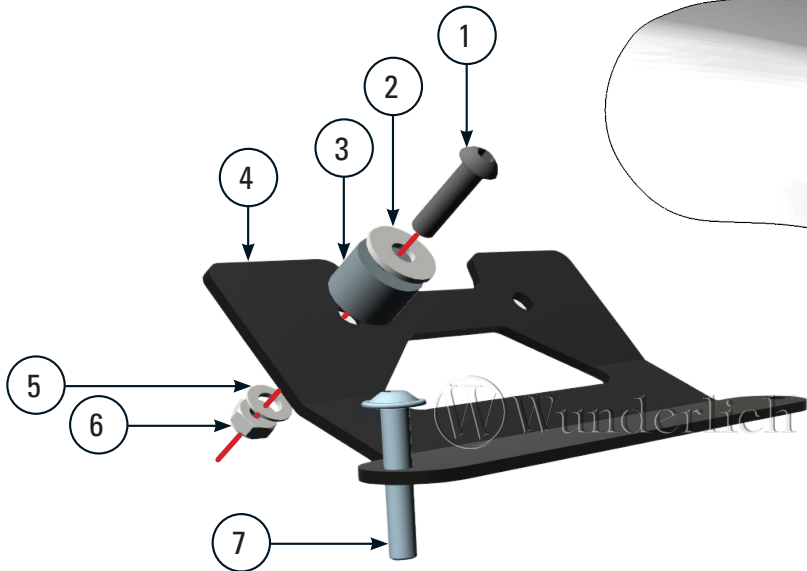
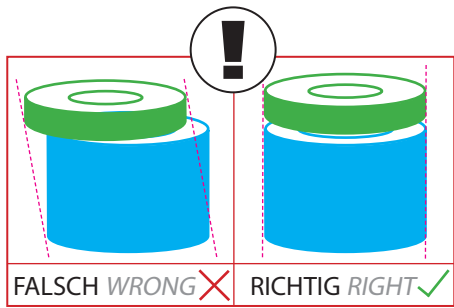

#	BEZEICHNUNG	MENGE
1	Linsenkopfschraube M6 x 25	2
2	U-Scheibe 9021SA2-6	2
3	Distanzhülse D 18,0-d 8,5-h 13,5mm	2
4	Halblech	1
5	U-Scheibe 125SA2-6	2
6	Sechskantmutter M6	2
7	Linsenflanschschraube M6 x 35 8Nm	2
8	Sitzbank	1
9	Linsenflanschschraube M6 x 12 6Nm	2
10	Linsenflanschschraube M6 x 12 8Nm	2
11	U-Scheibe 9021SA2-6	2
12	Halblech SH	1

**LEGENDE / KEY**

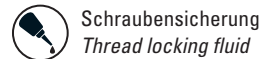

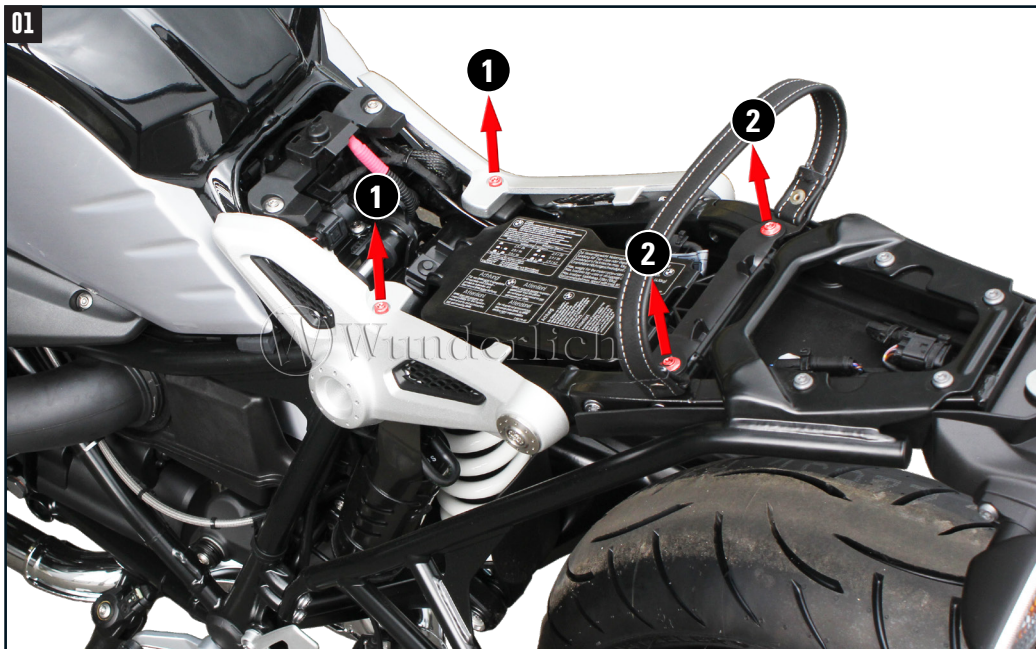

01 Vorab original Sitzbank demontieren. Schrauben 1 und 2 entfernen, Pos. 2 entfällt.  
 Disassemble the original seat in advance. Remove screws 1 and 2, Pos. 2 is omitted.

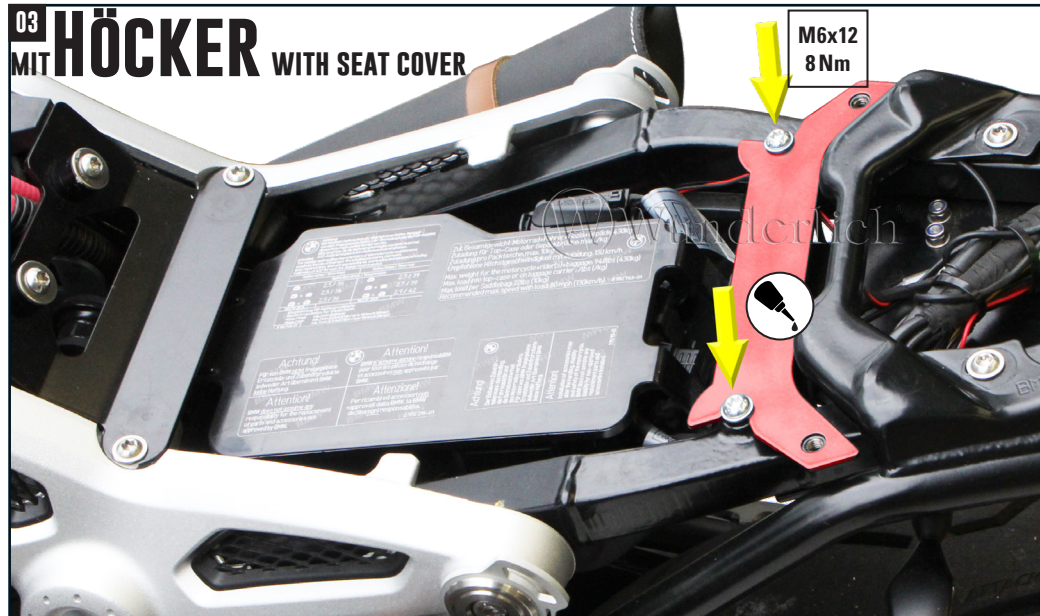
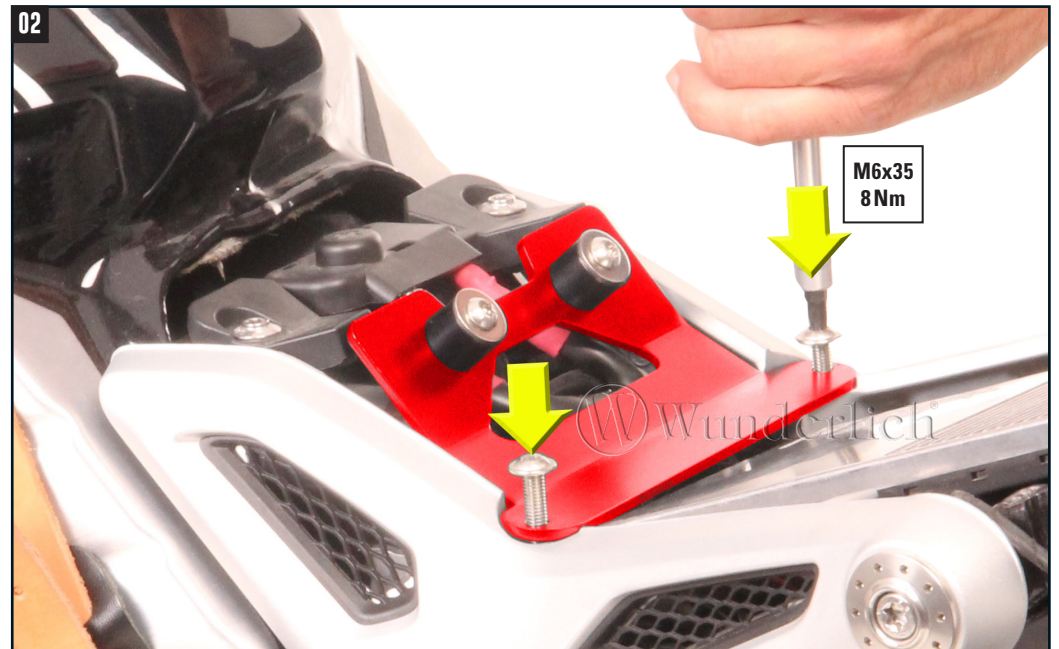

03 **MIT HÖCKER** WITH SEAT COVER  
 Paßt auch mit 31742-3xx.  
 Also fits with 31742-3xx.

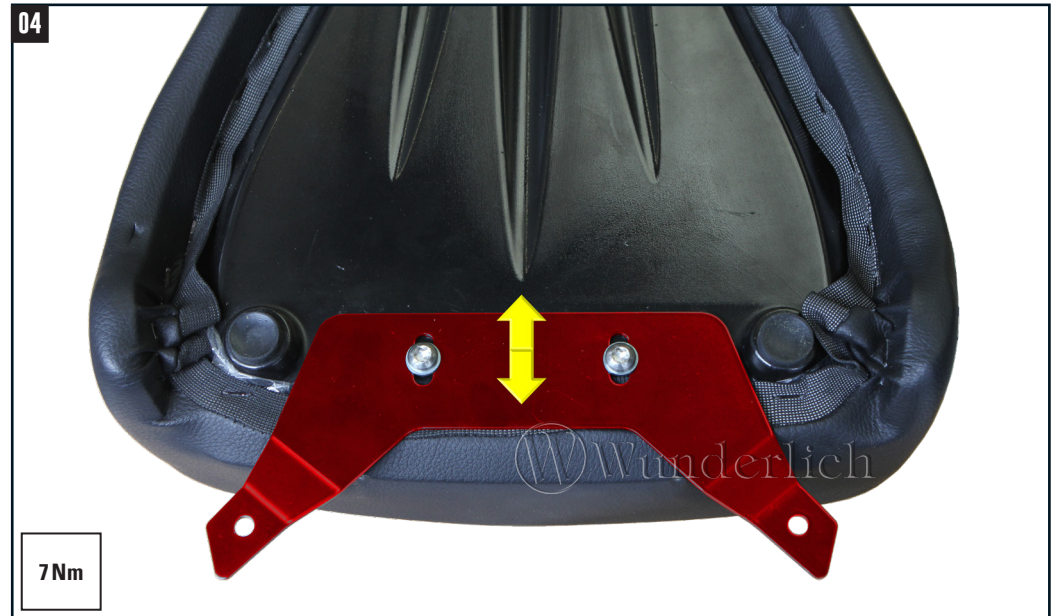

04 Halter so ausrichten, das sich Höcker oder Beifahrersitz spannungsfrei montieren lassen.  
 Adjust the bracket until the hump or passenger seat can be mounted free of strain.

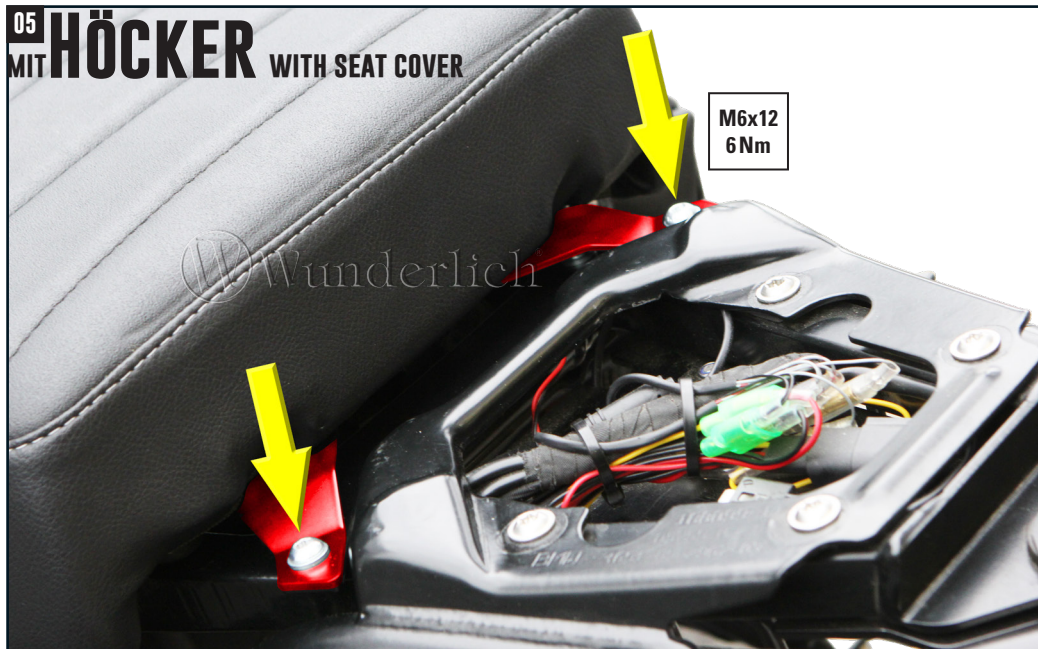

Höcker vorne in die Führung einschieben und hinten wieder verschrauben.  
*Insert the pillion seat cover in the front of the guide and screw the seat back on again.*

